

# BAX<sup>®</sup> Prep Xpress

## User's Manual

P/N 6602850-01, Revision B



# Contents

<b>1 About</b>	<b>05</b>
1.1 About this Manual	05
1.2 Intended Use of the Prep	05
1.3 Product Identification	06
1.4 Disposal	08
1.4.1 Americas/Pacific Rim	08
1.4.2 European	08
<b>2 Safety</b>	<b>10</b>
2.1 Safety Symbols	10
2.2 Operation	10
2.3 Maintenance	11
2.4 Programming	11
2.5 Electrical	11
2.6 Computer	11
<b>3 Instrument Overview</b>	<b>12</b>
3.1 Pipetting Features of the Prep	12
3.1.1 Air Displacement Pipetting	12
3.1.2 Disposable Tip Attachment with CO-RE Technology	13
3.1.3 Tip-On Recognition	14
3.1.4 Tip Size Recognition	14
3.1.5 Capacitive Liquid Level Detection (cLLD)	14
3.1.6 Monitored Air Displacement (MAD)	14
3.2 Features of the Base Instrument	15
3.2.1 Pipetting Arm	15
3.2.2 Deck	15
3.2.3 Touchscreen	15
3.2.4 Deck Scan	16
3.2.5 Waste	16
3.3 Configuration Options	17
3.3.1 Independent Channels	17
3.3.2 8-Probe Head	19
3.3.3 CO-RE Paddles	19

3.4 Pedestals .....	20
3.4.1 Tip Pedestals .....	20
3.4.2 Tube Pedestals .....	20
3.4.3 Reagent Pedestals.....	21
3.5 Disposable CO-RE Tips .....	21
3.5.1 Nestable Tip Racks (NTRs) .....	22
3.5.2 Framed Tip Racks (FTRs).....	22
3.6 Accessories .....	22
3.6.1 Barcode Reader .....	22
<b>4 Installation .....</b>	<b>23</b>
4.1 Site Considerations .....	23
4.2 Setup .....	24
<b>5 Operation .....</b>	<b>25</b>
5.1 Software Overview .....	25
5.2 Running a Protocol.....	26
5.3 After a Run.....	28
5.4 Error Handling .....	29
5.5 Getting Help.....	29
<b>6 Maintenance .....</b>	<b>30</b>
6.1 Intervals .....	30
6.2 Materials Required .....	30
6.2.1 Daily Maintenance.....	30
6.2.2 Weekly Maintenance .....	30
6.2.3 Yearly Maintenance .....	30
6.2.4 Stop Disc and O-Ring Replacement .....	31
6.2.5 Pipetting Head Replacement .....	31
6.2.6 Decontamination.....	31
6.3 Accessing Maintenance .....	32
6.4 Routine Maintenance .....	33
6.4.1 Daily Maintenance.....	33
6.4.2 Weekly Maintenance .....	34
6.4.3 Yearly Maintenance .....	35

6.4.4 Stop Disc and O-Ring Replacement .....	38
6.4.5 Data Maintenance.....	39
6.4.6 Database Backup .....	39
6.5 Pipetting Head Replacement.....	40
6.6 Decontamination .....	44
6.7 Packing.....	44
<b>7 Parts and Accessories .....</b>	<b>45</b>
7.1 Disposable Tips.....	45
7.1.1 50 µL CO-RE Tips .....	45
7.1.2 300 µL CO-RE Tips .....	45
7.1.3 1000 µL CO-RE Tips .....	45
7.2 Waste.....	46
7.3 Teaching Needles.....	46
7.4 Accessories .....	46
7.5 Service Parts.....	47
7.6 Maintenance Fluids .....	47
<b>8 Technical Specifications .....</b>	<b>48</b>
8.1 Instrument Specifications .....	48
8.2 Pipetting Specifications .....	49
8.3 Barcode Reader.....	50
8.3.1 Supported Symbologies .....	50
8.3.2 Barcode Specifications .....	51
<b>9 Appendix.....</b>	<b>52</b>
9.1 Getting Technical Assistance.....	52
9.1.1 Global Support .....	52
9.1.2 Finding the Software Version.....	52
9.2 Warranty .....	53
9.3 Regulatory.....	54
9.3.1 Declaration of Conformity.....	54

## 1 About

### > 1.1 About this Manual

This manual describes the components and functionality of the BAX® Prep Xpress Liquid Handling System and will guide users to program and run protocols on the Prep correctly and safely.

All efforts have been made to ensure the accuracy of the contents of this manual. Hygiena™ can assume no responsibility for any errors in this manual or their consequences. If any errors are found, please contact Hygiena™.

Reproduction of any part of this manual in any form whatsoever without the express written consent of Hygiena™ is forbidden. The contents of this manual are subject to change without notice.

Copyright© 2021 Hygiena™. All rights reserved.

The BAX® Prep Xpress will be referred to as the Prep for the remainder of this manual.

### > 1.2 Intended Use of the Prep

The Prep is a low-cost, entry-level pipetting instrument. It can be equipped with 2 independent channels, an 8-Probe Head, or both. The Prep is intended for applications such as liquid transfers, hit-picking, serial dilution, reagent dispensing, and PCR prep.

The Prep is small enough to fit inside select fume hoods. Placing the Prep inside a hood may affect laminar air flow. Hygiena™ issues no guarantee of the resulting hood performance— this must be checked by the laboratory.

The Prep is designed to be serviced without the help of Hygiena™ Trained Field Service Engineers. Users can perform routine preventative maintenance and parts replacement in addition to daily and weekly maintenance. The software comes with video tutorials to aid users in servicing the Prep.

> 1.3 Product Identification





Figure 1–1 shows the location of the product identification label on the Prep.



Figure 1–1: Locating the product identification label



Figure 1–2: Product label detail

	<p>EC Declaration of Conformity The CE marking is the manufacturer's declaration that allows sale of product in the EU that the produce meets the requirements of the applicable EC directives. It is a mandatory conformity marking for certain products sold within the European Economic Area (EEA).</p> <p>ROHS Directive 2011/65/EU</p>
	<p>This device complies with part 15 of the FCC Rules and Part VI, Interference, of the Canadian Radiocommunication Regulations. Operation is subject to the following two conditions: (1) This device may not cause harmful interference, and (2) this device must accept any interference received, including interference that may cause undesired operation.</p>
	<p>The CSA C/US mark signifies that the product is certified for both the U.S. and Canadian markets, to the applicable U.S. and Canadian standards.</p>
	<p>CHINA-RoHS</p> <p>All Electronic Information Products (EIP). Extensive list published which includes many products not covered by EU RoHS such as radar attached to aircraft or ships, medical equipment, measurement instruments, some production equipment, batteries and most types of components.</p> <p>The number is the Environmentally Friendly (safe use) Period or EFUP, denoting the number of years before any substance is likely to leak out into the environment. Orange is preferred but any prominent color may be used.</p>
	<p>WEEE (Waste of Electrical and Electronic Equipment)</p> <p>This directive represents recycling, sorting and handling of product. The symbol for separated collecting of electrical and electronic equipment shows a crossed out bin on wheels.</p>

## > 1.4 Disposal

### > 1.4.1 Americas/Pacific Rim

**After the life cycle of the Prep has ended, disposal must be considered.** The customer is responsible for proper disposal of electronic devices per local regulations.

### > 1.4.2 European

#### **WEEE Declaration**

Recycling of Hygiena™ Prep instruments is in accordance with EC directive WEEE.

**The European Community requires from manufacturers to organize the disposal and Waste of Electrical and Electronic Equipment (WEEE).** For this reason, Hamilton Bonaduz AG took part in an initiative to organize the disposal of Prep products through a European disposal network called RENE. RENE is the largest recycling network for the disposal of electronic equipment in Europe.

**The mission of RENE is a European-wide, WEEE-compliant, high quality recycling for electrical and electronic equipment through a dense network with both innovative and SMB-sized partner companies.** As a consequence, Hamilton Bonaduz AG gets a turn-key-solution that includes all processes from treatment of incoming orders over collection, logistics and recycling down to reporting and the according management of material flows.

#### **Hygiena™ offers a WEEE process in collaboration with Toolpoint and RENE AG:**

- Request for the collection of the Hygiena™ instrument via Toolpoint Home Page ([www.toolpoint.ch](http://www.toolpoint.ch)).
- Completion of the decontamination confirmation form
- Preparation for transport: packing
- Activation of the recycling order
- Archiving of the decontamination confirmation
- Disposal of instrument

### Responsibilities

Ordering Party	<ul style="list-style-type: none"> <li>• Decontamination</li> <li>• Preparation for transport</li> </ul> <p>Note: The cost for decontamination and preparation for shipment is paid by the ordering party. On request, Hygiena™ offers to take care of that part of the recycling process.</p>
RENE	<ul style="list-style-type: none"> <li>• Transport</li> <li>• Disposal</li> </ul>
Toolpoint	<ul style="list-style-type: none"> <li>• Registration</li> <li>• Invoice the disposal to Hygiena™</li> </ul>
Hygiena™	Organize the disposal in accordance with the WEEE directive



## Recycling process

- 1. Request the disposal of the instrument.** Access to the order registration is given by the Toolpoint homepage [www.toolpoint.ch](http://www.toolpoint.ch).
  - Recycling
  - Order registration form
- 2. Complete the decontamination form.** Once the form has been completed, the request for disposal is automatically activated and transferred to Toolpoint. The confirmation of the order will be sent to the registered contact person.
- 3. Decontaminate the instrument.** The ordering party is responsible for decontamination. It is mandatory to sign the decontamination form and send an electronic copy to Toolpoint. Toolpoint forwards the documentation to RENE, which is in charge with the disposal of the instrument.
- 4. Pack and prepare the instrument for shipping.** Instruments with a weight of over 30 kg need to be fixed on a euro pallet. Instruments below 30 kg can be packed in a cardboard or plastic box. A signed copy of the decontamination form needs to be added to the outer part of the shipping box or instrument.

## 2 Safety

### > 2.1 Safety Symbols



The general Warning symbol indicates the possibility of damaging the instrument or compromising the results of a method.



The Electrical Hazard symbol indicates the presence of electrical components that can be harmful to the operator if handled incorrectly.



The Mechanical Hazard symbol indicates the presence of moving mechanical parts that can be harmful to the operator if handled incorrectly.



The Hazardous Materials symbol indicates the presence of materials that are toxic or otherwise harmful to the operator if handled incorrectly.



The Biohazard symbol indicates the presence of biological samples that can be harmful to the operator if handled incorrectly.

### > 2.2 Operation



**WARNING:** When using the Prep, Good Laboratory Practices (GLP) must be observed. Suitable protective clothing, safety glasses, and protective gloves must be worn.



**WARNING:** Observe and perform the appropriate cleaning and decontamination procedures for any biohazardous samples. Wear gloves when handling the pipetting arm, labware, and tips. Avoid touching discarded tips. Any surfaces on which liquid is spilled must be decontaminated using the procedure in section 6.4.3.



**WARNING:** If the instrument crashes and is not user recoverable, refer to section 9.2 to view the warranty.



**WARNING:** Refer to the warranty in section 9.2 if at any time the instrument has lost accuracy or precision in any motion axis.



**WARNING:** The user is obligated to validate all protocols.

## > 2.3 Maintenance



**WARNING:** If the Prep becomes contaminated with biohazardous or chemical material, clean it in accordance with the maintenance procedures given in section 6.4.3.

## > 2.4 Programming



**WARNING:** Perform test runs first with tap water and then with the final liquids prior to routine use. The protocol programmer should supervise the run.



**WARNING:** Before using any newly-created or modified protocols for routine test purposes, they must be validated according to laboratory protocols.

## > 2.5 Electrical



**WARNING:** For reasons of data security and integrity, use of an uninterruptible power supply (UPS) is recommended, since a loss of power may cause data to be lost or corrupted.

## > 2.6 Computer



**WARNING:** Any manipulation of the Prep data or application files can result in erroneous test results or instrument failure.

## 3 Instrument Overview

### > 3.1 Pipetting Features of the Prep

**The Prep performs pipetting operations on liquids in containers.** Containers can be tubes, vials, microplate wells, or reagent reservoirs. A pipetting operation is defined as aspirating liquid from one container and then dispensing it into another container.

#### > 3.1.1 Air Displacement Pipetting

**The Prep uses air displacement pipetting heads to perform the pipetting operations.**

The pipetting heads work similarly to hand-held pipettes. A disposable tip is attached to the pipetting head, and then liquid is aspirated into and dispensed from that disposable tip. No system liquid is used in the instrument. A plunger within the pipetting head enables the movement of the liquid. The liquid in the tip never comes in contact with the pipetting head.



Figure 3–1: Air displacement pipetting principle

> 3.1.2 Disposable Tip Attachment with CO-RE Technology

**Tips are picked up using the patented Compression-induced O-Ring Expansion (CO-RE) technology.**

The technology enables very low force but high precision tip attachment, as well as gentle tip eject.



Figure 3-2: CO-RE technology tip pickup

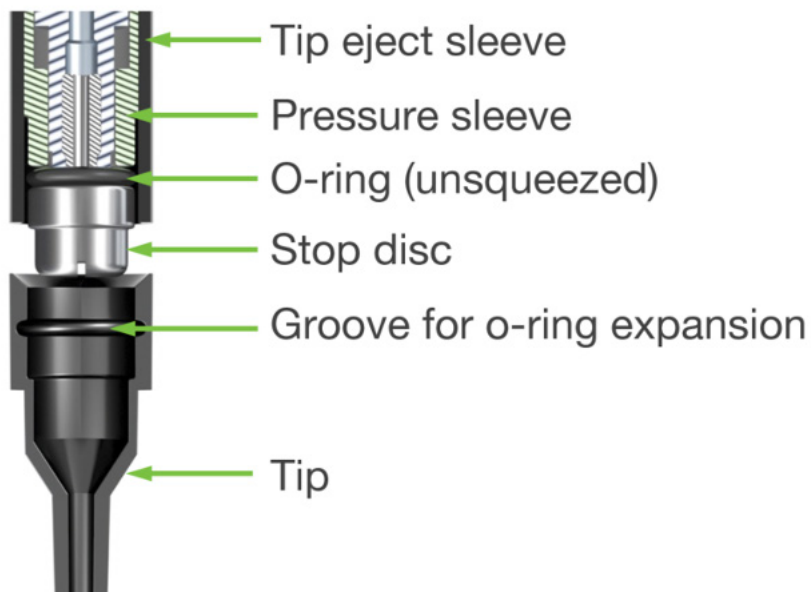

Figure 3-3: CO-RE technology components

The advantages of CO-RE technology include the ability to use disposable tips of various sizes as well as the use of various tools, all in the same run.

---

<sup>1</sup>Patents: EP 1171240, US 7033543

## > 3.1.3 Tip-On Recognition

**The Prep can detect whether a tip is attached to each channel.** When a tip is picked up, the tip eject sleeve is pushed upward, triggering a sensor. To eject tips, the tip eject sleeve moves downward, and the sensor indicates the tip has been released. This security feature prevents the accidental aspiration of liquid without a tip attached to the pipetting head.

## > 3.1.4 Tip Size Recognition

**The various tips have geometries that, when combined with the Prep's machine vision technology, allow the instrument to detect their different sizes.** This prevents the accidental pick-up of 300  $\mu$ L tips, for example, when 1000  $\mu$ L tips are expected. The Prep also uses the camera and software to help identify and manage other types of labware on the deck; refer to section 3.2.4 for details.

**The Prep cannot differentiate between the 300  $\mu$ L and 50  $\mu$ L tips, or between filtered and non-filtered tips.** When using these kinds of tips, make sure the deck layout accurately reflects the tips used.

## > 3.1.5 Capacitive Liquid Level Detection (cLLD)

**The Prep channels can detect the liquid surface using capacitive sensors.** Capacitive LLD is used to detect the liquid level of fluids that are conductive while pipetting with conductive tips.



**WARNING:** Capacitive Liquid Level Detection (cLLD) does not function with the use of clear (non-conductive) tips.



**WARNING:** Liquid level detection needs to be explicitly tested when working with foamy liquids. Foam may affect the accuracy of liquid level detection.

## > 3.1.6 Monitored Air Displacement (MAD)

**Monitored Air Displacement allows aspiration to be monitored using a pressure sensor in the pipetting head.** The pressure is checked against values in the system to check for errors like aspirating air or tip clots. MAD can be enabled or disabled for any pipetting step in a protocol.

## > 3.2 Features of the Base Instrument

**This section describes the components that are common to all Prep instruments.**

**The instrument's power switch is located on the front of the Prep, below and to the left of the door handle.** Ports for connecting a USB external drive or a barcode reader are located on the left side of the instrument.

### > 3.2.1 Pipetting Arm

**The pipetting arm houses 2 independent channels, an 8-Probe Head, or both.** Refer to sections 3.3.1 and 3.3.2 for details on the channels and 8 MPH, respectively. The arm moves left and right over the deck of the Prep to access labware for pipetting and plate transport. never comes in contact with the pipetting head.

### > 3.2.2 Deck

**The deck of the Prep has eight sites for holding ANSI/SLAS footprint labware.**

Most microplates can be placed directly on the deck, but some labware will require Hygiena™ adapters, such as tubes and reagent reservoirs. The base plate for each site can be removed for labware that extends below its edges, such as tube pedestals and 1000 µL tip racks.

**The sites are numbered 1-8 starting from the back-left site, and counting toward the front.**

### > 3.2.3 Touchscreen

**The Prep comes with a touchscreen mounted to the enclosure and the intuitive Prep software pre-installed.** Protocols are created, managed, and run using the touchscreen; refer to section 5.1 for an overview on navigating the software.

**Tilt the touchscreen upward or downward to adjust its angle.**

### > 3.2.4 Deck Scan

**The Prep is equipped with a camera positioned above the deck to scan labware.**

This feature helps with building deck layouts and verifying labware before starting a run.

Refer to section 5.2 for details on using the camera during a run.

**Before adding steps to a protocol, a deck layout of all the required labware must be created.** The deck layout tells the protocol what labware is required and where it will be loaded, so the steps can reference the labware that will be pipetted (or otherwise operated on). The camera may be used to create the deck layout after placing labware on the deck. Similar-looking labware may need to be specified after scanning; for example, certain tip racks are difficult to differentiate from above.

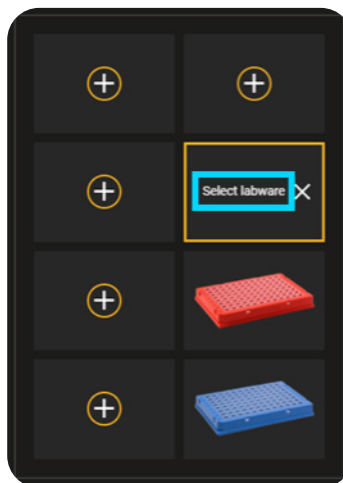

Figure 3–4: Specifying scanned labware

**The waste block is located to the right of the deck.** If the deck scan is skipped or there are open sites left after the scan, the sites can be tapped to open a list of labware.

### > 3.2.5 Waste

**The Prep is equipped with a camera positioned above the deck to scan labware.**

It is equipped with a waste bin, a teaching needle, a liquid waste tub, and CO-RE Paddles.

**The waste bin is located to the right of the waste block.** The waste bin can hold up to two racks' worth of ejected 1000  $\mu$ L tips. When the Prep is idle, the user can remove and empty the waste bin.

**A teaching needle and is located on the waste block.** The teaching needle is used for maintenance and calibration activities.



**Liquid waste is dispensed to a tub on the waste block.** The liquid waste tub drains to a removable 250 mL bottle in the waste bin, which should be emptied per laboratory protocols with the waste bin after each run.

**The waste block has park position brackets for the CO-RE Paddles.** Refer to section 3.3.3 for details on CO-RE Paddles. Both the park position brackets and the CO-RE Paddles have magnets that hold them in place.



Figure 3-5: CO-RE Paddle park position brackets

## > 3.3 Configuration Options

### > 3.3.1 Independent Channels

**The Prep can be equipped with two independent channels.** Each channel incorporates a pipetting head with a maximum volume of 1 mL, depending on the tip type used.

**The channels have independent spacing, meaning there is no fixed maximum spacing between channels.** The channels can access any two labware containers in the same column. The minimum possible spacing between the channels is 9 mm.

**The channels support the use of 50  $\mu$ L, 300  $\mu$ L, and 1000  $\mu$ L filtered and non-filtered disposable CO-RE tips.**

#### > 3.3.1.1 Channels

**The channel carries the pipetting head, which performs all pipetting steps and moves in the Y- and Z-directions.** The front and rear channels are built slightly differently to accommodate their 9 mm spacing.

### > 3.3.1.2 Pipetting Head

**The pipetting head performs all pipetting steps.** The Prep's pipetting heads are designed to be easily replaceable if a pipetting head breaks or loses accuracy. The front and rear channels use different pipetting heads to accommodate their 9 mm spacing; make sure to confirm which head must be replaced before ordering a new pipetting head. Refer to section 6.5 for instructions on replacing a pipetting head.

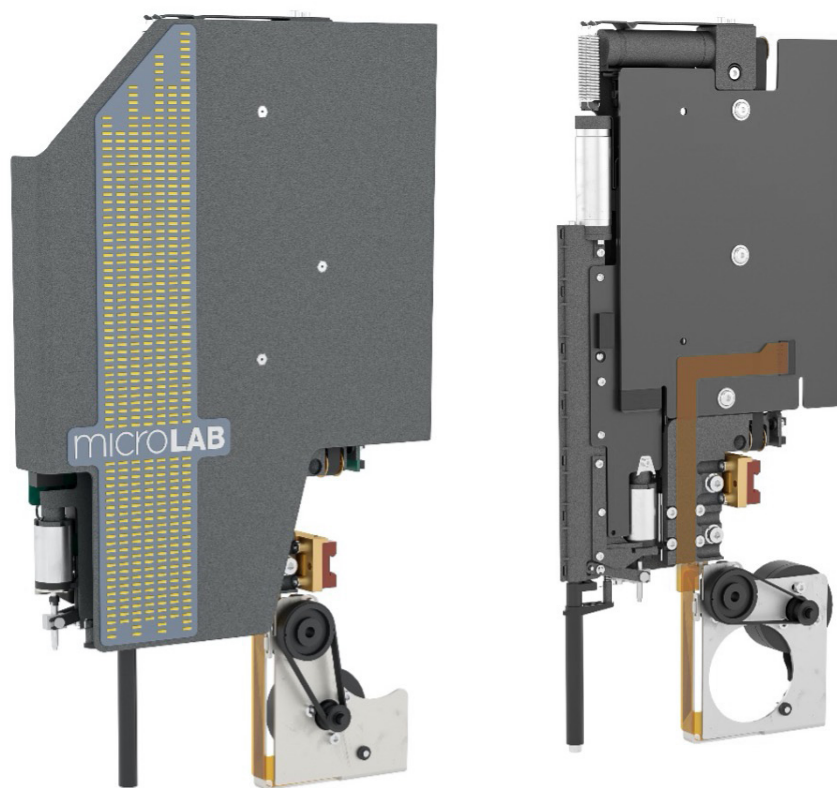

Figure 3–6: Front and rear channels

### > 3.3.2 8-Probe Head

**The Prep can be equipped with an 8-Probe Head (8 MPH).** The CO-RE technology guarantees fast and accurate pick-up and release of disposable tips.



Figure 3-7: 8-Probe Head

**The 8 MPH is comprised of eight 1 mL channels with a 9 mm raster,** combined into a single multi-probe head. The eight channels work simultaneously to pipette the same volume. Capacitive LLD is available on two of the eight channels, 1 and 8.

**The 8 MPH supports pipetting with intermediate volume (50  $\mu$ L), standard (300  $\mu$ L) or high volume (1000  $\mu$ L) disposable tips.** The multi-probe head is designed to be replaceable if it breaks or loses accuracy. Refer to section 6.4.4 for instructions on replacing a multi-probe head.

### > 3.3.3 CO-RE Paddles

**A Prep with channels can be equipped with CO-RE Paddles for transporting labware on the deck.** CO-RE Paddles are attached to park position brackets on the waste block. During a Transport step, the two channels pick up the CO-RE Paddles using their pipetting heads. They are then used to pick-up, move, and place the labware between the eight sites on the deck (or an HHS). After transport, the channels return the CO-RE Paddles to their park position brackets, freeing the pipetting heads to pick up tips and execute pipetting steps.

**Plate transport with the CO-RE Paddles is only allowed between the deck's sites.** Plate rotation is not possible with the CO-RE Paddles.



Figure 3-8: CO-RE Paddles

### > 3.4 Pedestals

**The Prep utilizes specially-designed pedestals to hold certain kinds of labware on the deck.** These pedestals can be moved for customized applications and for system maintenance and cleaning. This section describes the various pedestals available.

#### > 3.4.1 Tip Pedestals

**Tips in framed tip racks (FTRs) must be loaded on a tip pedestal.** If 1000  $\mu$ L tips are used, the base plate below the pedestal must be removed before loading the tips.



Figure 3-9: Tip pedestal

#### > 3.4.2 Tube Pedestals

**Tube pedestals can hold up to 24 sample tubes of the same type.** The large tube pedestal is loaded by removing the base plate on a site.

**Large and small tube pedestals are available, depending on the type of tube used.** Adapters are available for tubes that are too small for the tube pedestal.



Figure 3-10: Large tube pedestal

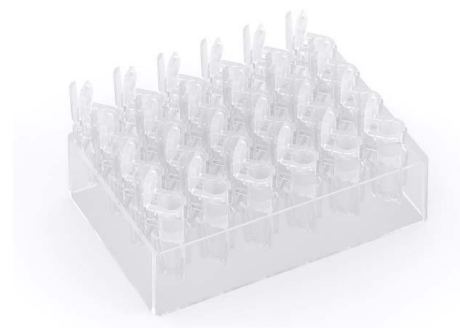

Figure 3-11: Small tube pedestal

### > 3.4.3 Reagent Pedestals

**Reagent reservoir pedestals can hold up to five 50 mL reagent reservoirs.** The reservoirs are made in a clean room environment (ISO 14644-1, class 8) and are pyrogen-, RNase- and DNase-free. They are self-standing and come with lids for reagent storage.

**The reagent reservoir pedestal can only be placed on the front two sites.** Otherwise, the lip on the front would cover containers on the labware in front of it.



Figure 3-12: Reagent reservoir pedestal

### > 3.5 Disposable CO-RE Tips

**Disposable CO-RE tips come in many sizes, with or without filter, in conductive black or non-conductive clear, and sterile or non-sterile.** All tips are produced under clean room conditions (ISO 14644-1, class 8) and are pyrogen-, RNase-, and DNase-free. Disposable tips for the Prep are only available through Hygiena™.



**WARNING:** Only use Hygiena™ tips on the Prep. Using other disposable tips can cause poor pipetting and cross-contamination.



Figure 3-13: Disposable tips

**The 50 µL and 300 µL unfiltered tips come in nestable tip racks.** Larger tips, or tips that are filtered, are only available in framed tip racks.

## > 3.5.1 Nestable Tip Racks (NTRs)

**Nestable tip racks (NTRs) are loaded directly onto deck sites.** NTRs come in a package of 5 stacks of 4 racks each.



**WARNING:** Do not stack tips in NTRs on the deck.

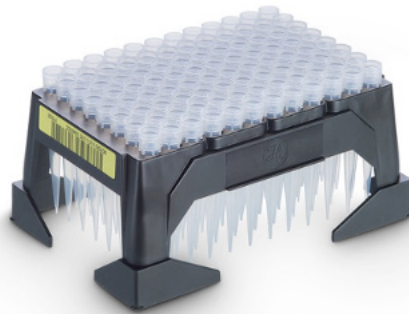

Figure 3–14: Nestable tip rack

## > 3.5.2 Framed Tip Racks (FTRs)

**Framed tip racks (FTRs) are loaded with a tip pedestal on the deck.** All tip types come in frame format, but 1000  $\mu$ L tips and filtered tips are only available in frames.



Figure 3–15: Framed tip rack

## > 3.6 Accessories

**A variety of accessories and other devices are available for use with the Prep.** This section describes the most common items. These items come with their own documentation describing their installation and use in detail.

### > 3.6.1 Barcode Reader

**A handheld USB barcode reader can be used with the Prep for sample tracking.** A user must read labware barcodes during a Read Barcodes step in a protocol.

## 4 Installation

### > 4.1 Site Considerations

**The Prep must be located on a stable surface that can accommodate the weight and dimensions of the instrument, as well as strain from the movement of the pipetting arm, without bowing or swaying.** Refer to section 8.1 for the full specifications; contact Hygiena<sup>™</sup> support for specific questions.



**WARNING:** At least two people are required to move the instrument, which weighs approximately 91.5 lbs. Always remove labware prior to moving the instrument.



**WARNING:** If the pipetting arm is not secured, it may slide during transportation.

**Protect the Prep from direct sunlight, excessive vibrations, and fluctuating temperatures or humidity.** This is especially critical for low volume (< 10  $\mu$ L) applications that require highly accurate pipetting.

**Provide sufficient space for documentation, labware, and maintenance materials.**

For optimum serviceability, it is best to position the Prep on an island location within the laboratory.

**Provide power outlets for the Prep.** Refer to section 8.1 for the power input requirements for the instrument.



**WARNING:** Main power voltage supply fluctuations are not to exceed 10% of the nominal supply voltage.

**Examine the packaging for any signs of damage.** If the crate or instrument has been damaged, refer to section 9.1.

**Verify the contents of the package with the packing checklist.** Each instrument comes with an accessory box with any ordered pedestals, as well as a set of tools packaged inside of the Prep. Refer to section 9.1 if any items are missing.



## > 4.2 Setup

**Instructions for installing the Prep are provided in a booklet packaged with the instrument.**

The booklet also comes with ordering information for tips and other consumables. If the booklet is lost or misplaced, refer to section 9.1.

**Before using the Prep, some basic settings need to be configured.** The first time the Prep is powered on, a startup wizard will guide the user through the settings required to set up the instrument.

- 1. Tap Next on the welcome page to begin setup.**
- 2. Select the laboratory's time zone and enter the date and time.** This information is included in run reports and used to track when protocols were last run or edited.
- 3. Enter an admin username, password, and password recovery questions.** Tap the numbered buttons to navigate between recovery questions. Other users can be added later; user management can also be disabled, if it is not needed.
- 4. Tap Next and choose how to manage labware imports.** The entire library of labware supported by the Prep can be imported now, or the specific labware required for the laboratory can be imported later.
- 5. If the labware library was imported, select labware from the library as favorites.** Tap the favorite toggle to the right of the desired labware to mark it as a favorite. If the desired labware is not present, contact Hygiena™.
- 6. Tap Skip to choose favorites later.**
- 7. Tap Next after selecting favorites.** Favorites can be added or removed at any time from the File Manager.
- 8. Wait for the Prep to calibrate.** Follow the instructions onscreen to complete calibration.
- 9. Tap Finish to complete setup.** The Prep is now ready to use. The tips may be unloaded if they have not been removed already.



## 5 Operation

### > 5.1 Software Overview

The Prep is operated using the intuitive, one-of-a-kind software installed on the touchscreen. Protocols, settings, and maintenance are all accessed through this software.

**Tap a protocol to open it for editing, simulating, or running.** Up to eighteen favorite protocols are shown on the home page; view a list of all protocols by tapping Browse. New protocols are automatically added to favorites until no more spaces are available. Favorites are managed in the File Manager under settings. If no protocols exist, the Prep will prompt the user to create a new protocol.

**Controls for accessing settings and related activities are located at the top-right corner of the page:**

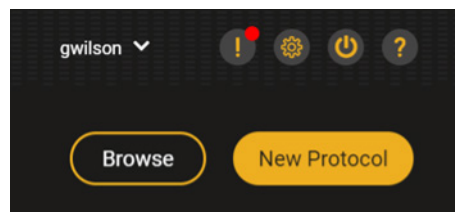

Figure 5–1: Home page buttons

- **Users can sign out or change their password using the drop-down menu.** Passwords can also be changed from the User settings page. Users can also set up password recovery in case they forget their password; up to three recovery questions can be added.
- **When maintenance is required, it can be accessed through a shortcut using the alert button.** Protocols cannot be run if maintenance is required. Refer to sections 6.4.1 and 6.4.2 for instructions on daily and weekly maintenance, and sections 6.4.3 and 6.4.4 for details on preventative maintenance.
- **Settings are accessed through the button with the gear icon.** Maintenance, tutorials, and file management are all accessed through settings, in addition to other software and instrument settings.
- **Power off the Prep using the power button.** The power button is only accessible on the home page and login page.
- **Most pages have contextual help available.** Tap the help button in the upper-right corner to view information specific to the current page. Information about other pages may also be accessed through the table of contents.

## > 5.2 Running a Protocol

1. **Turn on the Prep.** Log in if user management is enabled.
2. **Open the door.** Pull the door handle upward until it stops in place.
3. **Make sure the waste bin is empty before beginning the run.**
4. **Tap the desired protocol.** The overview page appears. Navigate to the Labware tab to view the number and type of labware required to run the protocol.
5. **Tap Run to begin setup.** Protocols may also be simulated from this page.
6. **If the protocol has a How Many Samples step, select which wells or tubes to use for the highlighted labware and tap Next.** Any steps that use the highlighted labware will be restricted to the selected containers.
7. **If the protocol has a Read Barcodes step, scan or enter each expected barcode, then tap Next.** The barcodes are used for sample tracking only. If the Prep has a handheld barcode reader connected by USB, use it to scan the barcodes. Otherwise, enter the barcode(s) manually using the virtual keyboard.
8. **If prompted, tap Browse to select a worklist with the required data for any Hit Picking steps, then tap Next.** Double-check the requirements for the worklist before selecting a file.
9. **Load the labware and consumables specified onscreen, then tap Scan.** Load labware, tips, samples, and reagents onto their designated site, using pedestals as necessary for reagent reservoirs and tubes. Make sure there are enough tips to run the protocol.

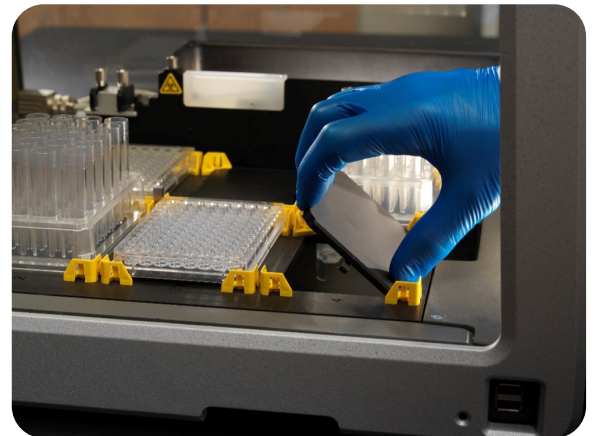

Figure 5–2: Removing a base plate

To load labware such as tube pedestals, 1000  $\mu$ L tips (in an FTR), and half-skirted PCR plates, remove the site's base plate first. Hold the front edge of the plate down and lift on the back edge to remove the base plate.



**WARNING:** Do not overfill reagent reservoirs, tubes, or other liquid containers.



**WARNING:** Do not load anything that sits higher than 78 mm above the deck.

**10. Correct any labware that does not match the layout, then tap Confirm.** Labware like tip racks may need to be specified before proceeding.



**WARNING:** When loading labware, pay close attention to the identity and status of the detected labware and the labware specified in the protocol.

**11. Monitor the progress of the run on the page.** The estimated time remaining is shown on the run timer. Containers that are being aspirated from and dispensed to will flash purple and blue on the deck layout, respectively. Labware that is being heated or shaken will also flash, and a second timer for that step will be shown.

While simulating, the speed can be changed in the Step View using the slider below the run timer. The speed is set to real time (1x) by default; it can be changed to 2x, 5x, 10x, or 0.5x the default speed.

- **Open the Plate View to display a detail of selected labware.**

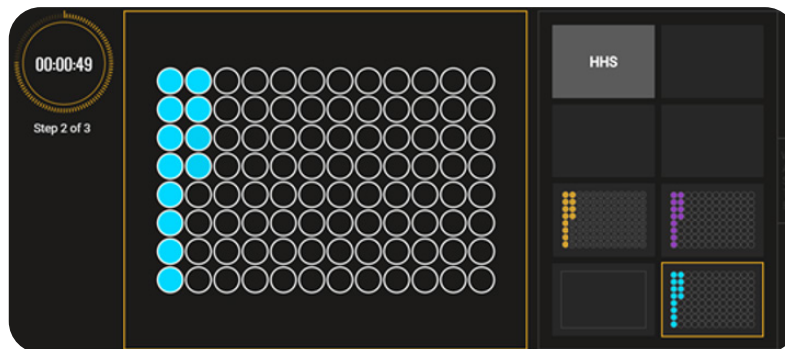

Figure 5–3: Run page plate view

- **Tap Pause to pause the run.** The Prep will finish the last command it received and then come to a stop. The door may be opened and closed while the run is paused. Tap Resume to continue the run once the door is closed.
- **To abort a run, tap Stop.** A confirmation dialog will appear; tap Abort to confirm. The Prep will finish the last command it received, come to a stop, and the protocol will be aborted.
- **Aborted protocols must be restarted from the beginning.** If the protocol aborts with tips (or CO-RE Paddles) still attached to the channels or 8 MPH, the tips (or CO-RE Paddles) will be ejected next time the pipetting arm is initialized, like at the beginning of a run.
- **If tips or reagents must be refilled, a dialog will appear listing what is needed to continue the run.** Replenish the specified consumables and tap Finished.

### > 5.3 After a Run

When a run is finished, the dialog shown in Figure 5–4 appears. Tap Report to view the run report for the protocol. Run reports may be accessed at any time through the Run History settings page.

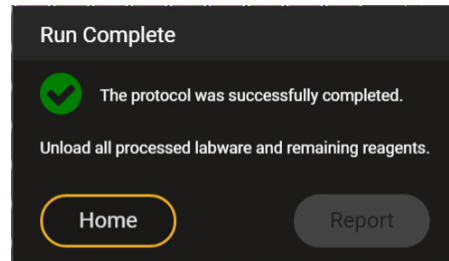

Figure 5–4: Finishing a run

1. **Remove empty tip racks and processed labware.**
2. **Remove or refill reagents.** If spills occur, clean them up immediately. Refer to section 6.4.3 for the recommended decontamination procedure.
3. **Empty the waste bin and liquid waste bottle.**



**WARNING:** Empty the waste bin as soon as it is full, but only after a run is complete or if the instrument is paused.



**WARNING:** Waste may contain biohazardous or chemically contaminated material.

4. **Select the next protocol to run,** if required.
5. **After all runs are completed, turn off the Prep.** At the end of the day, perform Daily or Weekly maintenance. Refer to sections 6.4.1 and 6.4.2 for maintenance procedures.

## > 5.4 Error Handling

**Some errors that could occur during a run will generate an error dialog with recovery options.**

This section describes some common recovery options. The available options depend on the type of error that has occurred. Run History settings page.

- **Abort** will abort the current protocol, stopping the instrument in its current position
- **Air** will raise the tips to a clearance height and aspirate air for aspiration errors
- **Cancel** will abort the current protocol and park the pipetting arm (but will not eject tips)
- **Exclude Channel** will continue without using the channels that generated the error until the next tip pickup
- **Move to Next** will make channels pick up tips from the next position(s) on a tip rack for tip pickup errors
- **Repeat** will retry the action that generated the error

## > 5.5 Getting Help

**If the Prep encounters persistent errors, How To Guides are available on the installed USB drive or by request at [diagnostics.support@hygiena.com](mailto:diagnostics.support@hygiena.com).**

**If the available How To Guides do not solve the problem, please email [diagnostics.support@hygiena.com](mailto:diagnostics.support@hygiena.com) to create a case record and to get additional help. Make sure to have the following information ready when submitting the email:**

- Name
- Software version (see section 9.1.3 for details)
- Site location
- Serial number
- Log file
- Description of problem

## 6 Maintenance

**Periodic maintenance is required in order to assure safe and reliable operation of the Prep.**

Maintenance must be performed by the user in order to keep the instrument clean and to maintain proper functionality.

### > 6.1 Intervals

**The appropriate maintenance be performed at the following intervals:**

- Daily: cleaning and inspection recommended every 24 hours
- Weekly: deck cleaning recommended every seven days
- Yearly: cleaning and lubrication of the Prep's mechanisms recommended every year
- Every 20,000 tip eject cycles (approximately every six months): replacement of stop discs and o-rings



**WARNING:** Observe and carry out the maintenance procedures given. Failure to do so may impair the reliability or functionality of the Prep.

### > 6.2 Materials Required

#### > 6.2.1 Daily Maintenance

- Personal protective equipment (gloves, eyewear, lab coat)
- Clean, lint-free towels
- Deionized water

#### > 6.2.2 Weekly Maintenance

- Personal protective equipment (gloves, eyewear, lab coat)
- Clean, lint-free towels
- Deionized water

#### > 6.2.3 Yearly Maintenance

- Purchased from Hygiena™:
  - Silicone oil
- Supplied by lab:
  - Personal protective equipment (gloves, eyewear, lab coat)
  - Clean, lint-free towels
  - Deionized water
  - Lint-free cotton swabs

## > 6.2.4 Stop Disc and O-Ring Replacement

- Purchased from Hygiena<sup>™</sup>:
  - Set of stop discs (2-pack for channels, 8-pack for 8 MPH)
  - Stop disc glue (included with stop discs)
  - Rack of tips
  - Stop disc removal tool
- Supplied by lab:
  - Personal protective equipment (gloves, eyewear, lab coat)
  - Clean, lint-free towels
  - Deionized water

## > 6.2.5 Pipetting Head Replacement

- Purchased from Hygiena<sup>™</sup>:
  - Replacement front/rear pipetting head or multi-probe head
  - Pipetting head removal tool (if replacing front/rear pipetting head)
  - Rack of tips
- Included with Prep:
  - 2 mm hex wrench (if replacing front/rear pipetting head)
  - 3 mm hex wrench (if replacing multi-probe head)
- Supplied by lab:
  - Personal protective equipment (gloves, eyewear, lab coat)

## > 6.2.6 Decontamination

- Personal protective equipment (gloves, eyewear, lab coat)
- Clean, lint-free towels
- Microcide SQ. This is a cleaner and broad-spectrum disinfectant for use on Hygiena<sup>™</sup> instruments. It is a colorless, low foaming liquid. The concentrate comes with a spray bottle. Dilute the concentrate with deionized water according to the instructions on the bottle.



**WARNING:** Do not use cleaning or disinfecting solutions that contain hypochlorite, such as bleach, on the instrument.



**WARNING:** Do not use an acetone-based solution to clean the enclosure. It can cause micro-fractures.

### > 6.3 Accessing Maintenance

When maintenance is due on the Prep, the required routine can be accessed through the alert button if maintenance alerts are enabled in the maintenance setting. Users may not be able to run protocols until the required maintenance is completed, depending on the maintenance setting.

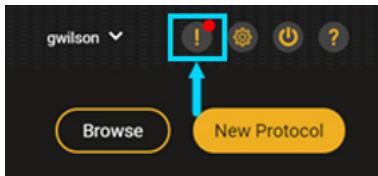

Figure 6-1: Alert button

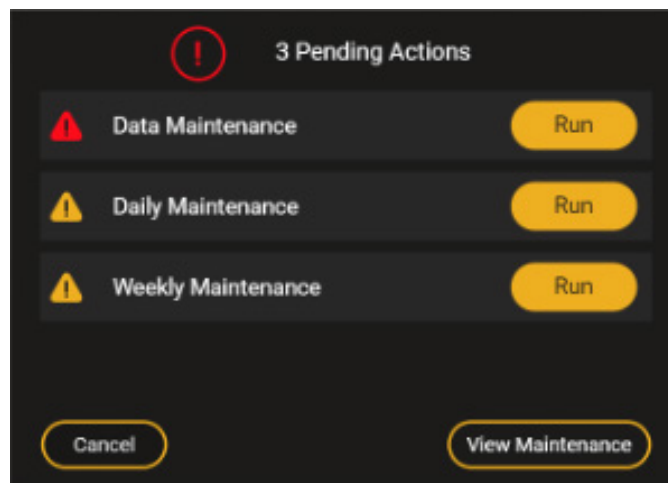

Figure 6-2: Starting maintenance through the alert button

**Maintenance is accessible at any time on the Maintenance Routines page.** Tap the settings button, select the Maintenance tab, and then tap Maintenance Routines. All maintenance procedures are listed here with the last date they were completed and when they must be performed next.

**Select the required routine and tap Run.** Each routine has a set of dialogs to guide the user through its required tasks.



## > 6.4 Routine Maintenance

### > 6.4.1 Daily Maintenance

**Daily maintenance requires the following tasks to be performed:**

- Inspect tip eject sleeves and o-rings
- Inspect deck and calibration post
- Inspect the waste block and liquid waste
- Inspect the HHS
- Empty waste bin and liquid waste
- Clean tip eject sleeves and o-rings

**The following procedure describes each task in detail:**

- 1. Make sure to wear appropriate PPE for the lab.**
- 2. Run the daily maintenance protocol.** Refer to section 6.3 for instructions on locating and running maintenance protocols.
- 3. Inspect the tip eject sleeves and o-rings.** Make sure the tip eject sleeves can move up and down freely, and that the stop discs are undamaged and aligned with the tip eject sleeves.  
If a stop disc is damaged, refer to section 6.4.4 for instructions on how to replace it.
- 4. Inspect the deck.** Make sure the following components are secure and undamaged:
  - a. Corner brackets
  - b. Calibration post
  - c. Waste block
  - d. Liquid waste bottle
  - e. HHS (if no devices are installed, check the cover for the connector)
- 5. Empty the waste bin and liquid waste bottle. Clean the waste bin and liquid waste bottle according to laboratory procedures.**

6. **Spray a clean, lint-free towel with deionized water and wipe down the tip eject sleeves.**
7. **Spray a clean, lint-free towel with deionized water and wipe down the stop discs.**  
Lift the tip eject sleeve to expose the stop discs and o-rings.

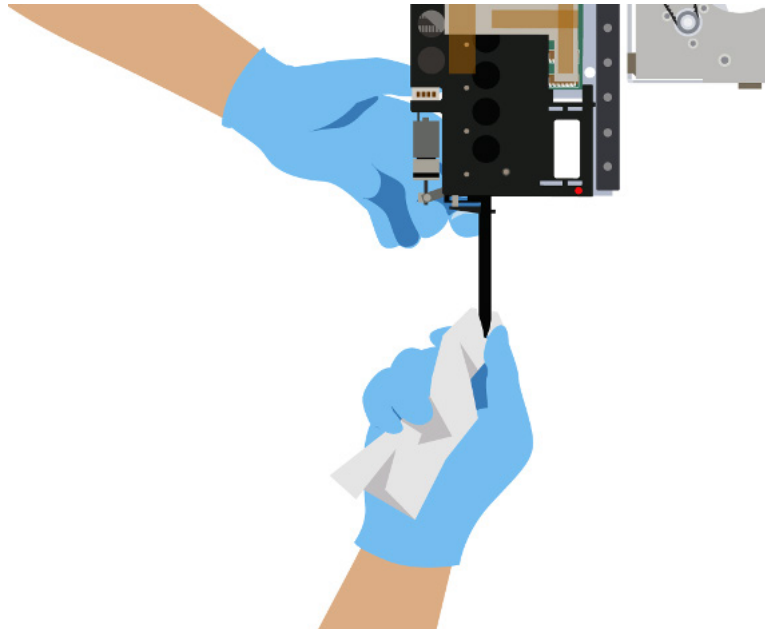

Figure 6–4: Cleaning stop discs and o-rings

8. **Clear the deck and close the door when prompted.** The pipetting tools will each pick up the teaching needle and perform their tightness and cLLD checks, after which maintenance is done.

#### > 6.4.2 Weekly Maintenance

**Weekly maintenance consists solely of cleaning the deck and any devices.**

Daily maintenance should be run along with weekly maintenance when required.

1. **Make sure to wear appropriate PPE for the lab.**
2. **Run the weekly maintenance protocol.** Refer to section 6.4 for instructions on locating and running maintenance protocols.
3. **Spray a clean, lint-free towel with deionized water and wipe down the following components.** Do not spray the Prep with water directly.
  - a. Deck area
  - b. Waste block
  - c. Calibration post

### > 6.4.3 Yearly Maintenance

**Once a year, the Prep must be cleaned and lubricated to maintain best performance.**

Please schedule with Hygiena™ to have a Technical Support Specialist onsite for this process.

- 1. Make sure to wear appropriate PPE for the lab.** Gloves are especially important for cleaning and lubrication.
- 2. Run the yearly maintenance protocol.** Refer to section 6.3 for instructions on locating and running maintenance protocols.
- 3. Clear any labware from the deck and close the door.** The Prep will move either the front channel or the 8 MPH into position for cleaning.  
If the Prep does not have independent channels, skip to step 11. If the Prep does have channels, continue to step 4.
- 4. Open the door and wipe down the front channel's lead screw with a clean, dry cloth.** **Wrap the cloth** around the lead screw, then pull gently on each end to clean the lead screw.

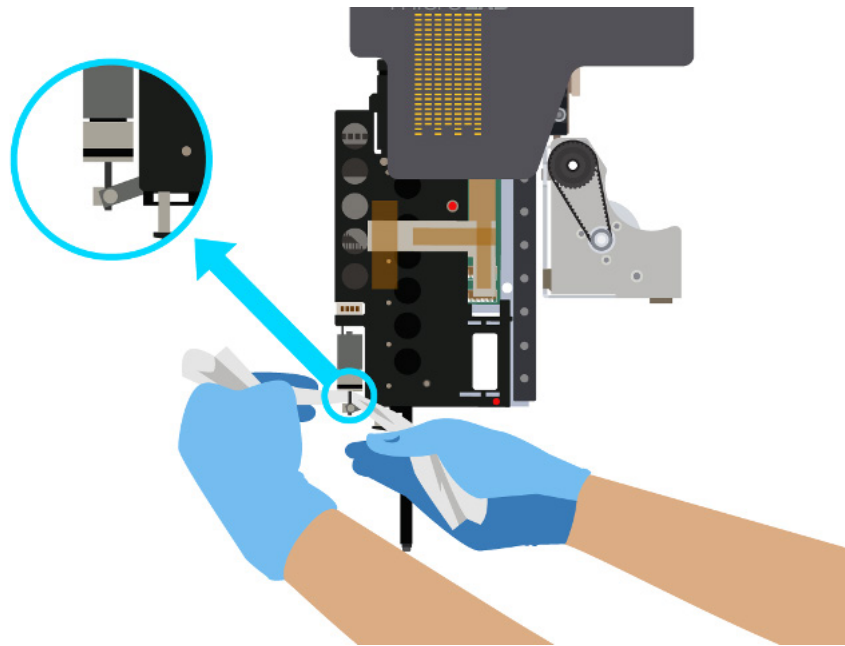

Figure 6–5: Cleaning the front channel's lead screw

5. **Apply a small amount of silicone oil to the front channel's lead screw** using a clean, lint-free cotton swab.

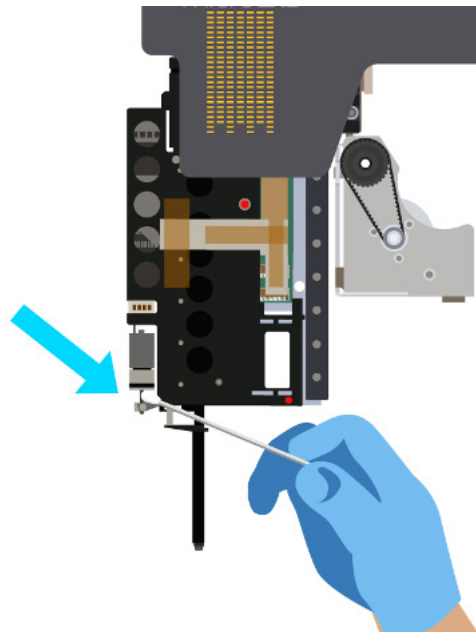

Figure 6-6: Oiling the front channel's lead screw



**WARNING:** When lubricating lead screws, use only a couple drops of oil to avoid contaminating the Prep.

6. **Close the door when finished with the front channel.** The Prep will position the rear channel for cleaning.
7. **Repeat steps 4 through 6 for the rear channel.** Note that its lead screw is located to the right of the tip eject sleeve.  
If the Prep does not have an 8 MPH, skip to step 11. If the Prep does have an 8 MPH, continue to step 8.

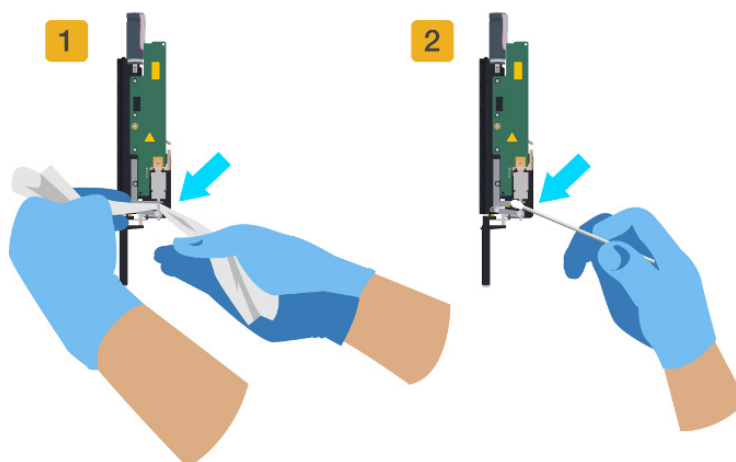

Figure 6-7: Cleaning and lubricating the rear channel

8. **Wipe down the 8 MPH's lead screw with a clean, dry cloth.** The lead screw can be difficult to access if the Prep has channels; wipe down as much of the lead screw as possible.
9. **Apply a small amount of silicone oil to the 8 MPH's lead screw** using a clean, lint-free cotton swab.



**WARNING:** When lubricating lead screws, use only a couple drops of oil to avoid contaminating the Prep.

10. **Close the door.** The Prep will move the channels and/or 8 MPH out of the way for the next step.
11. **Open the door and wipe down the following parts with a clean, dry cloth:**
  - a. The pipetting arm's lead screw
  - b. Both pipetting arm rails

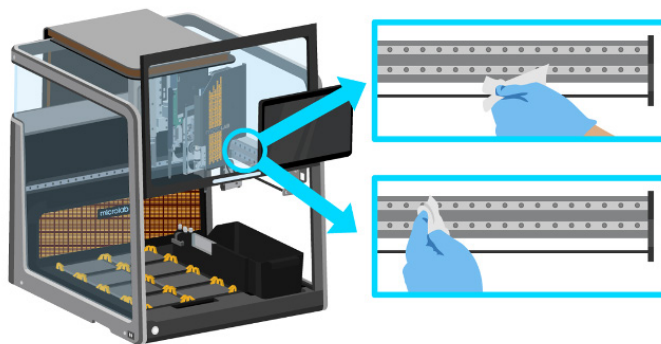

Figure 6-8: Cleaning the pipetting arm's lead screw and rails

- c. The two rails at the back of the prep

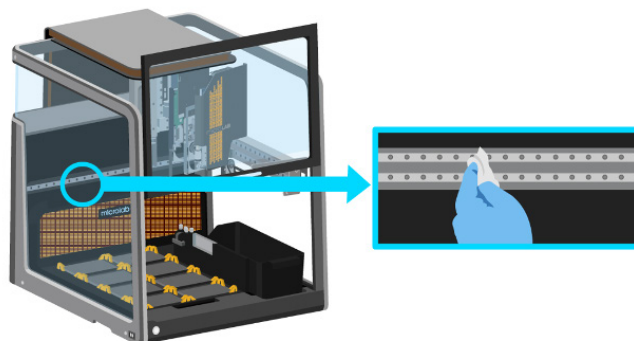

Figure 6-9: Cleaning the rails at the back of the Prep

12. **Apply a small amount of silicone oil to the front, middle, and back of the pipetting arm's lead screw** using a clean, lint-free cotton swab.



**WARNING:** When lubricating lead screws, use only a couple drops of oil to avoid contaminating the Prep.



**WARNING:** Do not apply oil to any parts other than the specified lead screws.

13. **Close the door and tap Finish.** The Prep will move the channels and pipetting arm to spread the oil.

#### > [6.4.4 Stop Disc and O-Ring Replacement](#)

**By default, the Prep requires new stop discs and o-rings after 20,000 tip eject cycles, which occurs approximately every six months** depending on the Prep's tip usage.

**The following procedure describes the steps for stop disc and o-ring replacement in detail.** Refer to section 6.3 for information on accessing preventative maintenance routines.

1. **Make sure to wear appropriate PPE for the lab.** At minimum, gloves are required for stop disc and o-ring replacement.
2. **Run the appropriate “Replace stop discs and o-rings” protocol.** Refer to section 6.4.4 for instructions on locating and running maintenance protocols.
3. **Clear any labware on the deck and close the door.** The Prep will move the pipetting arm and tools into position. Open the door again when prompted.
4. **Use the stop disc removal tool to unscrew the old stop disc** from the pipetting head or multi-probe head, along with the old o-ring and washer.
5. **Apply glue to 2–3 threads of the new stop disc.** The new stop disc requires a small amount of glue on its threads to hold it in place.



**WARNING:** Do not get any glue on the washer or o-ring, or inside the stop disc; otherwise, the stop disc will have to be replaced.

6. **Pull the new stop disc out of its rubber strip.** Twisting the stop disc may help to remove it.

**7. Make sure the o-ring and washer are properly attached to the new stop disc.**

The o-ring should rest between the top of the stop disc and the washer. Double-check that no glue is on the washer or o-ring before proceeding.

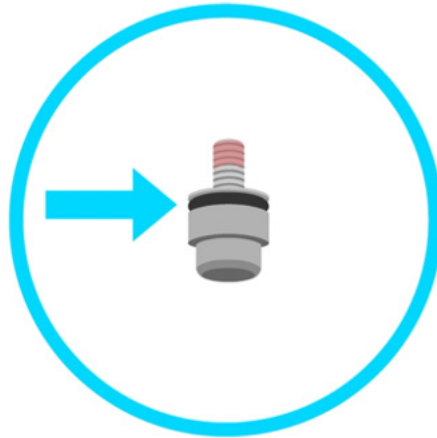

Figure 6-10: Checking the stop disc assembly

**8. Screw the new stop disc onto the pipetting head or multi-probe head by hand.**

The washer may need to be adjusted slightly to make it fit properly in place.



**WARNING:** Do not use any tools to tighten the new stop disc. Doing so will damage the pipetting head.

**9. Wipe down the new stop disc** with a clean, lint-free towel sprayed with deionized water.

**10. Repeat steps 4–9 as necessary.** All eight stop discs on the multi-probe head must be replaced. The pipetting heads for the channels only have one stop disc each, but they should be replaced at the same time for consistent performance.

**11. Close the door when prompted.** The Prep will start the calibration procedure for the new stop discs and o-rings. Follow the instructions onscreen to complete calibration.

> [6.4.5 Data Maintenance](#)

**Traces and other data stored on the Prep must be regularly archived or deleted.**

When the amount of stored data reaches a certain size, data maintenance will be required (or recommended, depending on the level of maintenance warnings in the Prep's settings; refer to the Maintenance page help for details).

> [6.4.6 Database Backup](#)

**The Prep database must be regularly backed up in case of a problem with the software.**

These backups can be viewed, managed, or restored in the Prep's settings; refer to the Maintenance page help for details.

### > 6.5 Pipetting Head Replacement

If a pipetting head loses accuracy or functionality, it can be replaced by the user. Make sure the correct replacement pipetting head was ordered before replacing it.

1. **Make sure to wear appropriate PPE for the lab.**
2. **Make sure the Prep is turned off and disconnected from power.**
3. **Open the door and clear any labware from the deck.**
4. **Make sure the correct replacement pipetting head or multi-probe head was ordered.**  
Do not attach a front pipetting head to the rear channel, or vice versa—hardware errors will occur if the wrong pipetting head is installed.
5. **Carefully pull the desired pipetting head near the front of the pipetting arm.** Grip the channel at its base, where it attaches to the rails on the arm—do not touch any electronics, or grip the pipetting head by the black tip eject sleeve. Be sure the pipetting head is clear of the waste block.
6. **Gently pull the pipetting head or multi-probe head all the way down.**
7. **If replacing the front or rear channel's pipetting head:**
  - a. **Remove the two red screws indicated in Figure 6–11 using the 2 mm wrench included with the Prep.** The screws are located in the same place in both the front and rear pipetting head.

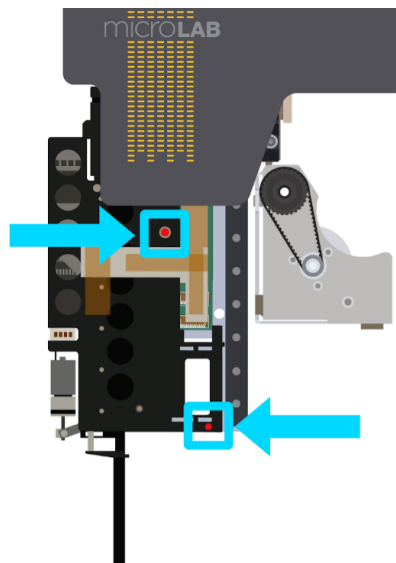

Figure 6–11: Locating pipetting head screws



- b. Examine the back of the channel before proceeding to see how the slots and tabs fit on a correctly installed pipetting head.** A pipetting head may “fit” without each of the four tabs lining up properly, which can cause errors later.

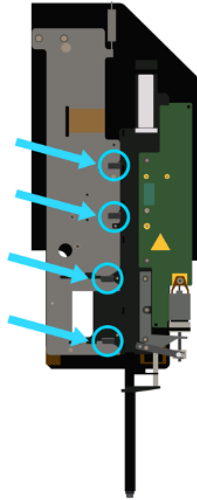

Figure 6-12: Checking the fit of a pipetting head's slots and tabs

- c. Push the pipetting head removal tool through the hole indicated in Figure 6-13.** The pipetting head will be ejected slightly, and can now be removed by pulling it to the left, away from the pipetting arm.

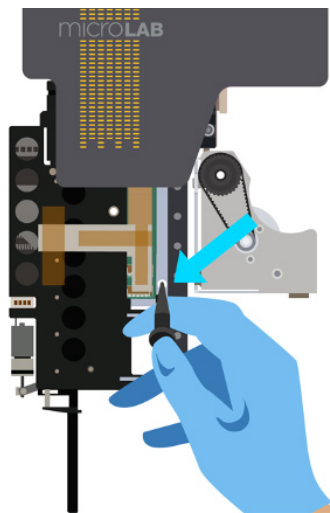

Figure 6-13: Ejecting a pipetting head

- d. Attach the new pipetting head.** Match the four plastic slots on the pipetting head to the metal tabs on the channel, then slide the pipetting head onto the channel until it clicks in place.
- e. Secure the new pipetting head using the same two red screws.** The new pipetting head includes replacement screws if needed.



**WARNING:** Do not install a front pipetting head on the rear channel, or vice versa. Hardware errors will occur if the wrong pipetting head is installed.

## 8. If replacing the multi-probe head:

- a. **Loosen the screw indicated in Figure 6–14 by a half-turn** using the 3 mm hex wrench included with the Prep.

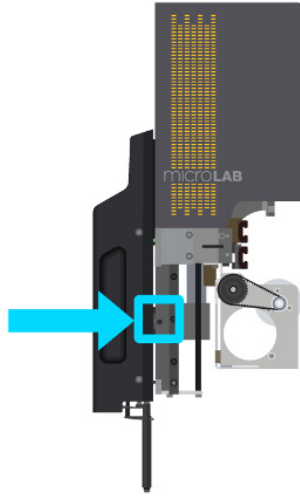

Figure 6–14: Locating the 8 MPH replacement screw

- b. **Grab the old multi-probe head by the grip and pull left until it detaches from the channel.** Hold the arm in place if need be.
- c. **Attach the new multi-probe head.** Match the black prong on the new multi-probe head to the hole on the channel and slide the multi-probe head onto the channel until it clicks in place.
- d. **Secure the new pipetting head by tightening the screw indicated in Figure 6–14.**
- e. **Visually check the alignment of the new multi-probe head.** All eight channels should be level. Push the 8 MPH to the back of the pipetting arm to visually check the alignment using the back edge of the Prep.

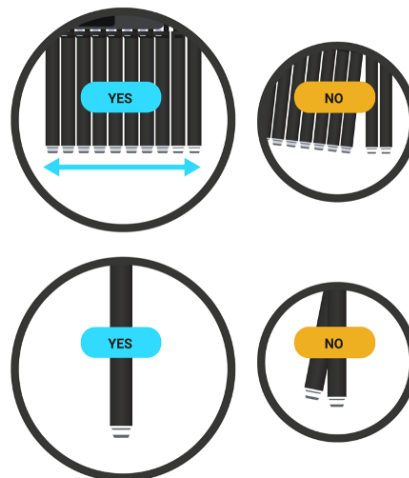

Figure 6–15: Checking a new multi-probe head's alignment

- 9. Move the channel with the new pipetting head (or the 8 MPH) to the same position near the front of the pipetting arm.** This will help ensure the pipetting head does not snag the flat flex cables inside the channel. Close the door when finished.
- 10. Reconnect the Prep's power cable and turn it on.** Sign in if required. The new pipetting head or multi-probe head must be calibrated using the replacement maintenance routine before it can be used.
- 11. Open the Maintenance Routines page.** Tap the settings button at the top-right corner of the home page, open the Maintenance tab, then select Maintenance Routines.
- 12. Select the "Replace a pipetting head" routine and tap Run.**
- 13. When prompted, select the pipetting head/multi-probe head that was replaced.**  
Tap the front pipetting head, rear pipetting head, or multi-probe head onscreen to select it. The Prep will begin calibrating the new pipetting head or multi-probe head. Follow the instructions onscreen to complete calibration.

## > 6.6 Decontamination



**WARNING:** Instruments, defective parts, and disposables must meet disinfectant and decontamination regulations prior to disposal.

**These instructions include recommendations and required materials for cleaning and decontamination.** Appropriate decontamination in the event of a hazardous material spill on or inside the instrument is the operator's responsibility.

**It is also the user's responsibility to avoid using decontamination or cleaning agents that could cause a hazard as a result of a reaction with the Prep or with any materials contained within.** Hygiena™ is to be consulted if there is any doubt about the compatibility of decontamination cleaning agents.

**The recommended decontamination procedure is as follows:**

- 1. Spray a lint-free cloth with 75% ethanol, Microcide SQ, or Deconex 61 DR.**
- 2. Wipe down the following components:**
  - a. The enclosure (inner and outer faces)
  - b. The deck and base plates
  - c. The pipetting channels (not the pipetting heads)
  - d. The waste block, including the waste bin, liquid waste tub, and liquid waste bottle



**WARNING:** Do not spray cleaning agents directly on the Prep.

## > 6.7 Packing

**In the event that the Prep needs to be returned for repair, it must be sent to Hygiena™ in its original packaging.** If the original packaging is damaged or lost, new materials can be ordered from Hygiena™. Email [diagnostics.support](mailto:diagnostics.support) for instructions on packing up the Prep.

## 7 Parts and Accessories

### > 7.1 Disposable Tips

#### > 7.1.1 50 µL CO-RE Tips

**The Prep uses air displacement pipetting heads to perform the pipetting operations.**

The pipetting heads work similarly to hand-held pipettes. A disposable tip is attached to the pipetting head, and then liquid is aspirated into and dispensed from that disposable tip. No system liquid is used in the instrument. A plunger within the pipetting head enables the movement of the liquid. The liquid in the tip never comes in contact with the pipetting head.

Product Name	Universal Part Number	Tip Type	Tip Color – Conductivity	Quantity per Each
50 µL Conductive Sterile Filter Tips	235979	Standard CO-RE Tip	Black – Conductive	Case of 5760 tips (Blister 5 x 96 tips per rack)
50 µL Nested Conductive Sterile Tips	235987	Standard CO-RE Tip	Black – Conductive	Case of 11,520 tips (Nested Tip Rack 5 x 4 stack)

#### > 7.1.2 300 µL CO-RE Tips

Product Name	Universal Part Number	Tip Type	Tip Color – Conductivity	Quantity per Each
300 µL Conductive Sterile Filter Tips	235938	Standard CO-RE Tip	Black – Conductive	Case of 5760 tips (Blister 5 x 96 tips per rack)
300 µL Nested Conductive Sterile Tips	235985	Standard CO-RE Tip	Black – Conductive	Case of 11,520 tips (Nested Tip Rack 5 x 4 stack)

#### > 7.1.3 1000 µL CO-RE Tips

Product Name	Universal Part Number	Tip Type	Tip Color – Conductivity	Quantity per Each
1000 µL Conductive Sterile Filter Tips	235940	Standard CO-RE Tip	Black – Conductive	Case of 5760 tips (Blister 5 x 96 tips per rack)

## > 7.2 Waste

Universal Part Number	Description
6603183-02	Waste bags, 50/roll
6603183-01	Biohazard waste bags, 50/roll
6603149-01	Waste bag wire stand
6600264-01	Liquid waste bottle

## > 7.3 Teaching Needles

Universal Part Number	Description
182176	Teaching needle

## > 7.4 Accessories

Universal Part Number	Description
186105	CO-RE Paddle
6600553-01	Framed tip rack pedestal
6600555-01	Tube pedestal Holds up to 24 full-size tubes. Tubes can be 10.5–16.0 mm in diameter and 75–125 mm in height.
6600409-01	Small tube pedestal Holds up to 24 microtubes. Microtubes can be 9.5–11.5 mm in diameter and 30–50 mm in height.
6600700-01	Reagent reservoir pedestal Holds up to five 50 mL reagent reservoirs.
6603432-01	Handheld barcode reader
6603189-01	Prep fume hood integration kit

## > 7.5 Service Parts

Universal Part Number	Description
6600318-01S	Front pipetting head
6600317-01S	Rear pipetting head
6600140-01S	Multi-probe head
6603039-01	Preventative maintenance kit, 2 stop discs
6603039-02	Preventative maintenance kit, 8 stop discs
6603034-01	Stop disc removal tool

## > 7.6 Maintenance Fluids

Universal Part Number	Description
3995-01	Microcide SQ Kit, consisting of an 8 oz. bottle of Microcide SQ plus an empty spray bottle
3896-01	Microcide SQ, 8 oz. bottle
3896-02	Microcide SQ, 32 oz. bottle
6603044-02	Silicone oil

## 8 Technical Specifications

### > 8.1 Instrument Specifications

Parameter	Specification
<b>Power</b>	
Input Power (Primary), Universal Supply	100–240 VAC, 50–60 Hz
Output Power (Secondary)	500 W at 48 V
<b>Physical Dimensions</b>	
Width	21 in / 534 mm
Depth (with screen)	25 in / 635 mm
Height	24 in / 610 mm
Height (door open)	32 in / 813 mm
Weight	91.5 lbs. / 41.6 kg
<b>Operation</b>	
Deck Capacity	Up to 8 positions
Plate Transport Mass	Maximum 300 g filled deep well plate
Communication	USB, Ethernet
Calibrated Positional Accuracy	0.5 mm
Positional Repeatability	0.125 mm
Operating Temperature	15–35°C (59–95°F)
Relative Humidity	15–85% non-condensing
Designed Life	7 years
<b>Storage</b>	
Storage Temperature	-20–70°C
Relative Humidity	10–90% non-condensing
<b>Regulatory Installation Ratings</b>	
CSA Certification Installation Category	II
Pollution Degree	2

Note: Indoor Operation and Use Only Per Section 3.6.6.2 “pollution degree 2” is defined as “normally only non-conductive pollution occurs (addition of foreign matter, solid, liquid, or gaseous (ionized gasses), that may produce a reduction of dielectric strength or surface resistivity).” Occasionally, however, a temporary conductivity cause by condensation must be expected.



> **8.2 Pipetting Specifications**

The design specifications in the following section is valid under the following conditions, obtained for measurements at Hygiena™:

- Test method: Gravimetric testing at Hygiena™. The scatter of the test method must be less than 1/6 of the specified precision (for one channel).
- Accuracy/Precision: The values given refer to use of two 1 mL pipetting channels.
- Test size: ≥10 single pipettings per channel with disposable CO-RE tips (pick-up and dispense, tip used only once) per channel and specified volume
- Test mode: Volumes ≥20 µL as jet dispense, <20 µL as (liquid) surface dispense
- Acceptance criteria: Measured values are within specifications if less than the values appearing in the following tables.
- Balance: Mettler Toledo WSX
- Test temperature: 20±2°C
- Relative humidity: 50±5%
- Test fluid deionized water with 0.1% NaCl, 0.01% Tween
- Test liquid temperature within ±0.5°C of room temperature

**No warranty can be given that the specifications for trueness and precision are met with any liquid or environment other than the ones specified.**

Disposable Tip Size	Pipetting Volume	Accuracy  R  (%)	Precision CV (%)
50 µL	1 µL*	5.0*	5.0*
50 µL	5 µL	2.5	2.0
50 µL	50 µL	2.0	1.0
300 µL	30 µL	2.0	1.5
300 µL	300 µL	1.0	1.0
1000 µL	100 µL	2.0	1.0
1000 µL	1000 µL	1.0	1.0

For pipetting of less than 10 µL, Hygiena™ recommends 50 µL volume disposable tips to achieve highest pipetting precision.

\*Independent channels only

### > 8.3 Barcode Reader

A handheld USB barcode reader can be integrated with the Prep.

Parameter	Specification
<b>Mechanical</b>	
Dimensions (W x D x H)	2.4 in x 7.1 in x 2.4 in (6.2 cm x 18 cm x 6 cm)
Weight	4.3 oz. (122 g)
<b>Electrical</b>	
Input Voltage	5 ± 10% VDC at 100 mA
Interface	USB
<b>Environmental</b>	
Operating Temperature	0–50°C (32–122°F)
Storage Temperature	-40–70°C (-40–158°F)
Relative Humidity	5–95% non-condensing
<b>Scan Performance</b>	
Scan Speed	100 scan/s
Scan Type	Bi-directional

#### > 8.3.1 Supported Symbologies

The following barcode symbologies can be detected by the system:

- UPC-A
- UPC-E
- Code 128-B
- EAN-13
- EAN-8
- Code 39 (no checksum)
- Interleaved 2 of 5 (no checksum)
- Codabar

> 8.3.2 Barcode Specifications

Parameter	Specification	
Length of String	Maximum 32 characters excluding start, stop and check characters, depending on the code length (see label dimensions).	
Code Density, Tolerance	<p>Minimum module width (X dimension) including a print tolerance: <math>\geq 0.0065</math> in (0.1651 mm)</p> <p>Maximum module width (X dimension) including a print tolerance: <math>\leq 0.02</math> in (0.508 mm)</p> <p>Best reading performance with X dimension <math>\geq 0.01</math> in (0.254 mm)</p>	
Check Character	Codabar	None
	Code 39	None
	Code 128	One character
Quiet Zone	$\geq 10$ times the X dimension, but at least 3 mm	
Print Contrast	Minimum contrast between bars and spaces (PCS): $\geq 80\%$ (at 632.8 nm)	
Print Quality	<p>The barcode print must be of a high quality. Offset, typographic, intaglio and flexographic printing are suitable.</p> <p>Mechanical dot matrix and thermo matrix printing are not suitable. The surface may be treated, sealed or plastic-coated.</p>	

## 9 Appendix

### > 9.1 Getting Technical Assistance

If additional assistance with the Prep is required, refer to section 5.5 for details on the online help center.

#### > 9.1.1 Global Support

Hygiena  
2 Boulden Circle  
New Castle, DE 19720

#### > 9.1.2 Finding the Software Version

To find the software version, navigate to the **Version** tab of the **Software Configuration settings**. The version info is also available on startup from the login page by tapping the help button.

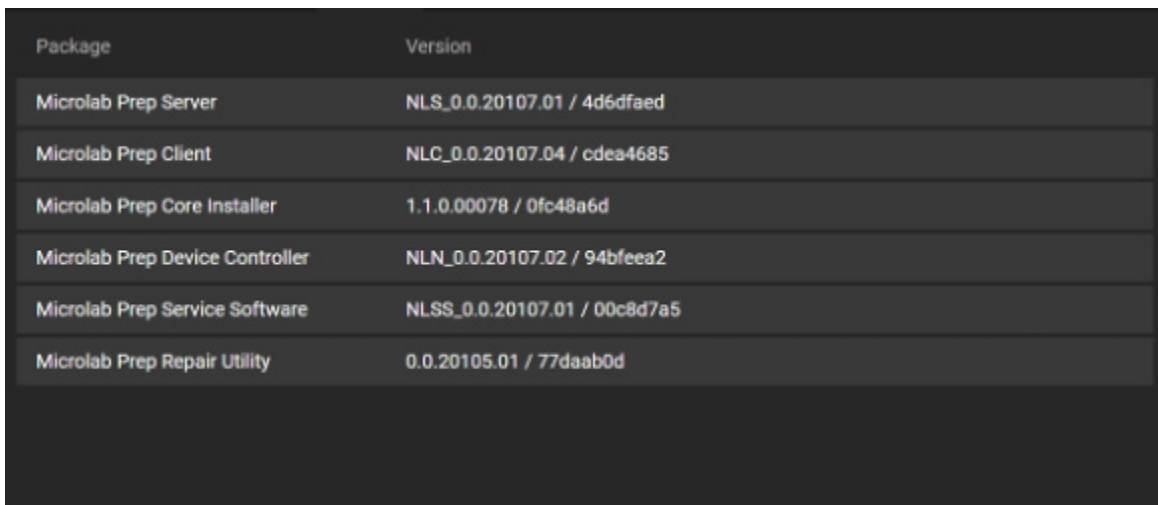
A screenshot of a software version information screen. It features a dark background with a table of software packages and their versions. The table has two columns: 'Package' and 'Version'. The packages listed are Microlab Prep Server, Microlab Prep Client, Microlab Prep Core Installer, Microlab Prep Device Controller, Microlab Prep Service Software, and Microlab Prep Repair Utility. Each package is followed by its version number and a hash value.

Package	Version
Microlab Prep Server	NLS_0.0.20107.01 / 4d6dfaed
Microlab Prep Client	NLC_0.0.20107.04 / cdea4685
Microlab Prep Core Installer	1.1.0.00078 / 0fc48a6d
Microlab Prep Device Controller	NLN_0.0.20107.02 / 94bfeea2
Microlab Prep Service Software	NLSS_0.0.20107.01 / 00c8d7a5
Microlab Prep Repair Utility	0.0.20105.01 / 77daab0d

Figure 9–1: Viewing software version on startup

## > 9.2 Warranty

**Hygiena™ warrants this product to be free of defects in material and workmanship for a period of 12 months from the date of delivery.** This warranty is extended to the buyer of record on the original purchase order to Hygiena™.

**A Hygiena™ representative will repair or replace, at its option and free of charge to the buyer at a normal place of business or at a Hygiena™ repair facility, any part or parts that, under proper and normal use, prove to be defective due to bad material, faulty design, or poor workmanship during the warranty period.\*** Abuse and unauthorized replacement, modification, or adjustment of parts made by anyone other than Hygiena™ or an assigned representative voids this warranty.

**This warranty gives the owner specific rights.** No other warranties, expressed or otherwise, including implications of warranties of merchantability and fitness for a particular product, are made.

### **This warranty does not apply if:**

- The product has not been operated in accordance with the user manual
- The product is not regularly and correctly maintained
- The product is not maintained, repaired, or modified by a Hygiena-authorized representative or user
- Parts other than original Hygiena™ parts are used
- The product and parts thereof have been altered without written authorization from Hygiena™
- The product is not returned properly packaged and secured.

**Hygiena™ endeavors to provide prompt and satisfactory service.** Hygiena's liability on the sale of all products shall be limited to repair, replacement, or refund of price of any defective product.

## > 9.3 Regulatory

The following list of regulatory requirements will be maintained for the Prep. The labelling will display the associated marks as listed.

Entity	Directive/Standard	Description	Safety	EMC	Environmental
UL	UL 61010-1 3rd Edition, July 19, 2019	UL Standard for Safety Electrical Equipment For Measurement, Control, and Laboratory Use; Part 1: General Requirements	X		
CSA	CSA C22.2 NO 6101-1 3rd Edition, 2017	Safety Requirements for Electrical Equipment for Measurement, Control, and Laboratory Use – Part 1 General Requirements	X		
FCC	47 CFR Part 15 subchapter B	Unintentional Radiators		X	
European Union	EU Directive 2014/35/EU	Low Voltage Directive	X	X	
WEEE	Directive 2012/19/EU	Directive on waste electrical and electronic equipment			X
RoHS	Directive 2011/65/EU	Restriction of the use of certain hazardous substances			X
China RoHS	China ROHS 2	GB/T 26572 the requirements for concentration limits for certain restricted substances in electronic and electrical products.			X

### > 9.3.1 Declaration of Conformity

The EU Declaration of Conformity is part of the delivery of the Prep. It validates that the instrument listed meets all required EU Directives.