



foodproof®

Listeria
monocytogenes
Detection Kit

MANUAL

Documentation for the qualitative detection of
Listeria monocytogenes DNA

Order No. KIT 2300 48

foodproof®

Listeria monocytogenes
Detection Kit

Order No. KIT 2300 48

Kit for 96 reactions for a
maximum of 94 samples

Store kit at -25 °C to -15 °C

For testing of food
and environmental samples

Approvals:



Manual:

Version 5, February 2022

TABLE OF CONTENTS

1. OVERVIEW 4

1.1 General Information 4

1.2 Applicability..... 4

1.3 Kit Contents 5

2. INSTRUCTIONS 6

2.1 Required Material 6

2.2 Precautions and Preparations..... 7

2.3 Enrichment and DNA extraction 8

 2.3.1 Certified Methods 8

2.4 Procedure..... 9

 2.4.1 Workflow 9

 2.4.2 Program Setup..... 10

 2.4.3 Data Interpretation 10

2.5 Troubleshooting 11

2.6 Support..... 12

3. ADDITIONAL INFORMATION 13

3.1 Testing Principle 13

3.2 Trademarks 14

3.3 Reference Number 14

3.4 Change Index 14

OVERVIEW

1. OVERVIEW

1.1 General Information

Number of Reactions

The kit is designed for 96 reactions with a final reaction volume of 25 µl each. Up to 94 samples plus positive and negative control can be analyzed per run.

Storage and Stability

Store all components at -25 °C to -15 °C. They are guaranteed to be stable through the expiration date printed on the label. Opening of the kit does not shorten the expiration date.

1.2 Applicability

The kit described in this manual has been developed for real-time PCR instruments with a FAM and a VIC/HEX detection channel. The performance of the kit was tested with the following real-time PCR instruments: LightCycler® 480, LightCycler® 96 (Roche Diagnostics), Applied Biosystems™ 7500 Fast (Thermo Scientific), Mx3005P® (Agilent), and others.

The **foodproof**® *Listeria monocytogenes* Master Mix is sequence-specific for a *mpl*-gene found in all subgroups of *Listeria monocytogenes*. Inclusivity has been tested with 102 *Listeria monocytogenes* isolates whereas all of them could be detected (100 % inclusivity). Exclusivity was determined using 60 non-*Listeria monocytogenes* bacteria.

A relative detection limit of 1 to 10 cells per 25 g sample can be achieved with all kinds of foods. The **foodproof**® *Listeria monocytogenes* Detection Kit detects down to 10³ - 10⁴ cfu/ml in enrichment cultures, depending on the sample preparation kit used: **foodproof**® StarPrep Two Kit or **foodproof**® ShortPrep II Kit.

OVERVIEW

1.3 Kit Contents

A schematic representation of the **foodproof®** *Listeria monocytogenes* Detection Kit with all its components.

KIT 2300 48

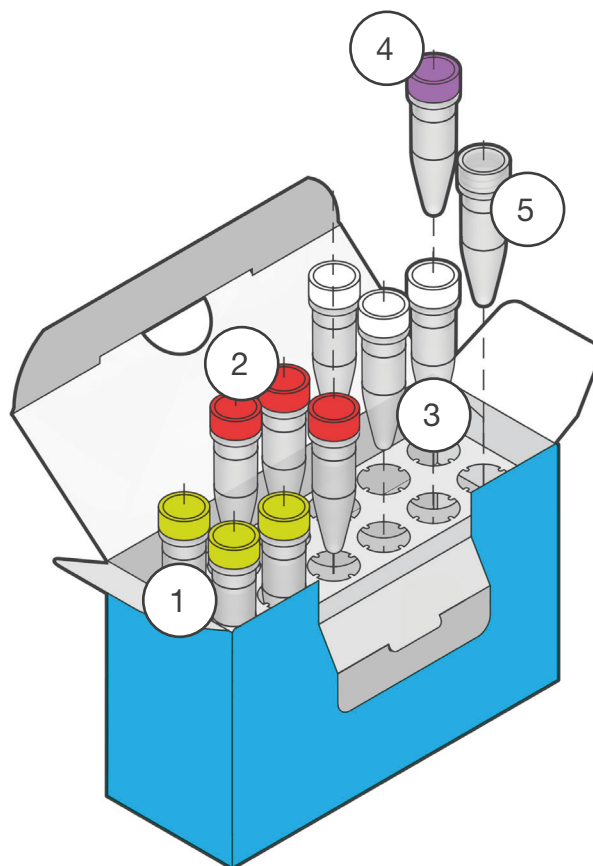

	Component	Details
1	Master Mix (yellow cap)	3 x 600 µl, ready-to-use primer and hydrolysis probe mix specific for parameter DNA and the parameter-specific Internal Control (IC). Store at -25 °C to -15 °C. Avoid repeated freezing and thawing! Protect from light!
2	Enzyme Solution (red cap)	3 x 32 µl, contains Taq DNA Polymerase and Uracil-DNA Glycosylase (heat labile) for prevention of carry-over contamination. Store at -25 °C to -15 °C.
3	Internal Control (white cap)	3 x 32 µl, contains a stabilized solution of plasmid DNA and a yellow dye for better visualization. For use as an internal amplification control. Store at -25 °C to -15 °C. Optional: After first thawing store at 2 °C to 8 °C for up to one month.
4	Control Template (purple cap)	1 x 50 µl, contains a stabilized solution of DNA. For use as a PCR run positive control. Store at -25 °C to -15 °C. Optional: After first thawing store at 2 °C to 8 °C for up to one month.
5	Negative Control (transparent cap)	1 x 1 ml, contains PCR-grade water. For use as a PCR run negative control. Store at -25 °C to -15 °C. Optional: After first thawing store at 2 °C to 8 °C for up to one month.

INSTRUCTIONS**2. INSTRUCTIONS****2.1 Required Material**

Most of the required equipment and reagents are available through Hygiena™. Please contact us for further information.



Use a real-time PCR cyclor suitable for detection of respective probes.

Material

- Nuclease-free, aerosol-resistant pipette **filter tips**

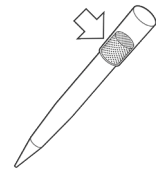

- Real-time PCR compatible **strips or plates** with optical cap or foil

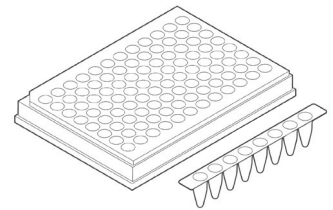

- Sterile **reaction tubes** for preparing PCR mixes and dilutions

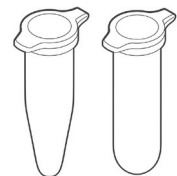

- PCR strip or plate centrifuge

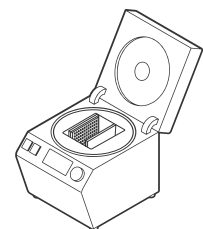

INSTRUCTIONS

2.2 Precautions and Preparations

The kit provides all reagents required for the PCR. However, in order to achieve reliable results, the entire assay procedure must be performed under nuclease-free conditions. Follow the instructions below to avoid nuclease, carry-over, or cross-contamination:

- Keep the kit components separate from other reagents in the laboratory.
- Use nuclease-free labware (e.g., pipettes, pipette tips, reaction vials).
- Wear gloves when performing the assay.
- To avoid cross-contamination of samples and reagents, use fresh aerosol barrier pipette tips.
- To avoid carry-over contamination, transfer the required solutions for one experiment into a fresh tube, rather than directly pipetting from stock solutions.
- Physically separate the workplaces for DNA preparation, PCR setup, and PCR to minimize the risk of carry-over contamination. Use a PCR hood for all pipetting steps.
- Sample Material:** Use any sample material suitable for PCR in terms of purity, concentration, and absence of inhibitors.
- DNA Extraction:** We provide sample preparation kits suitable for all kind of food samples and primary production stage samples.
- Positive Control:** Always run a positive control with the samples. Use the provided control DNA (Control Template) or a positive sample preparation control.
- Negative Control:** Always run a negative control with the samples. To prepare a negative control, replace the template DNA with PCR-grade water. Include a negative control during sample preparation to monitor reaction purity and cross-contamination. This extraction control can be used as an additional negative control reaction.
- Confirmation:** If required, positive results may be confirmed by appropriate methods (e.g., reference method).
- Waste Disposal:** All contaminated and potentially infectious material, like enrichment cultures or food samples, should be autoclaved before disposal and eliminated according to local rules and regulations. For more information, e.g., proper disposal of unused chemicals, please refer to the appropriate safety data sheet (SDS).



Keep the PCR mix away from light.

For more information, please refer to the appropriate safety data sheet (SDS). The SDS is available online at www.bc-diagnostics.com.

INSTRUCTIONS

2.3 Enrichment and DNA extraction

The **foodproof**[®] *Listeria monocytogenes* Detection Kit is intended for the rapid detection of *Listeria monocytogenes* DNA isolated from enrichment cultures prepared by valid methods and inoculated with all kinds of foods that are potentially contaminated with *Listeria monocytogenes*. The detection kit must not be used in diagnostic procedures.

Pre-enrichment broth and temperature according to ISO 11290 or BAM (Chapter 10) or USDA for 24 to 48 h. Other suitable, validated enrichment procedures can also be used.

Recommended DNA extraction kits:

- ⇒ KIT 2301 77 - StarPrep Two (suitable for most matrices)
- ⇒ KIT 2301 71 - ShortPrep II Kit (for a very quick extraction)

2.3.1 Certified Methods

This AOAC-RI validated kit is based on the **foodproof**[®] *Listeria monocytogenes* Detection Kit - Hybridization Probes (LightCycler[®] 1.x, 2.0) which has been AOAC RI and NordVal validated.

INSTRUCTIONS

2.4 Procedure

This protocol describes how to perform the analysis of DNA extracts by real-time PCR.

2.4.1 Workflow

Thaw the solutions, mix by flicking the tubes four to five times, and briefly spin vials in a microcentrifuge before opening.

1. PREPARE PCR MIX

Add 18 μ l of Master Mix (yellow cap), 1 μ l Enzyme Solution (red cap) and 1 μ l Internal Control (white cap) for each reaction to a suitable tube (n samples + 2 controls + at least one additional reaction to cover pipetting loss).

Mix carefully but thoroughly by pipetting up and down.

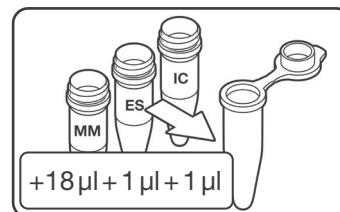

2. ADD PCR MIX

Pipette 20 μ l of prepared PCR mix into each strip or plate well.

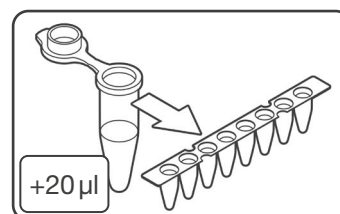

3. ADD SAMPLES AND CONTROLS

Pipette 5 μ l of samples, negative control (colorless cap) or Control Template (purple cap) into respective wells.

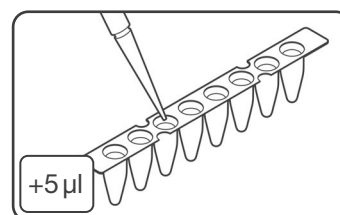

4. SEAL

Seal strips/plate accurately.

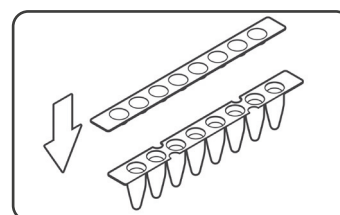

5. CENTRIFUGE

Briefly spin strips/plate in a suitable centrifuge.

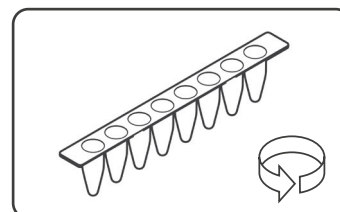

6. START REAL-TIME PCR RUN

Cycle samples as described in the program setup (2.4.2).

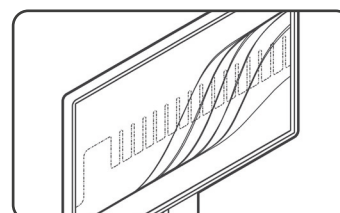

INSTRUCTIONS

2.4.2 Program Setup

Program your real-time PCR instrument before setting up the PCR reactions. Select the following channels:

- FAM (*L. monocytogenes*) and VIC (Internal Control).

As an alternative to VIC, HEX can be used. For the PikoReal® 24, Yakima Yellow has to be selected.

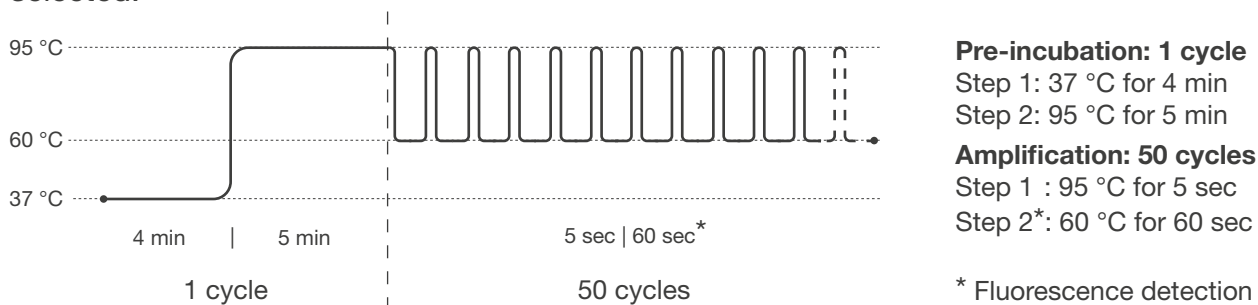

For some real-time PCR instruments the probe quencher as well as the usage of a passive reference dye has to be specified. This kit contains probes with TAMRA as quencher and no passive reference dye.

For users of the Agilent Mx3005P instrument: Click “Instrument” and “Filter Set Gain Settings” to open the Filter Set Gain Settings dialog box in which the gain settings may be viewed and modified. For FAM the Filter Set Gain Setting has to be modified to “x1”.

2.4.3 Data Interpretation

Verify results of positive (Control Template) and negative controls (H₂O), before interpreting sample results. Always compare samples to positive and negative control. Review data from each channel and interpret results as described in the table.

FAM	VIC	Result Interpretation
+	+ or -	Positive for <i>L. monocytogenes</i>
-	+	Negative for <i>L. monocytogenes</i>
-	-	Invalid

INSTRUCTIONS

2.5 Troubleshooting

Problem	Possible Cause	Recommendation
No signal increase is observed, even with positive controls.	Incorrect detection channel has been chosen.	Set channel settings for respective dyes accordingly.
	Pipetting errors.	Check for correct reaction setup and repeat the PCR run. Always run a positive control along with your samples.
	No data acquisition programmed.	Check the cycle programs.
A sample shows no signals, including the internal control. Positive and negative control have proper signals.	Inhibitory effects of the sample material (e.g., caused by insufficient purification).	Use the recommended DNA extraction kit. Dilute samples or pipette a lower amount of sample DNA (e.g., 20 µl PCR-grade water and 5 µl sample instead of 25 µl sample).
Negative control samples are positive.	Carry-over contamination.	Exchange all critical solutions and reagents for DNA/RNA extraction. Repeat the complete experiment with fresh batches of all reagents. Always handle samples, kit components and consumables in accordance with commonly accepted practices to prevent carry-over contamination. Add positive controls after sample and negative control reaction vessels have been sealed.
Fluorescence intensity is too low.	Inappropriate storage of kit components.	Store lyophilized PCR mix at 2 °C to 8 °C, protected from light and moisture.
	Low initial amount of target DNA.	If possible, increase the amount of sample DNA. Depending on the chosen DNA isolation method, inhibitory effects may occur.
	Reagents are not homogeneously mixed.	Mix reagents thoroughly before pipetting.
Fluorescence intensity varies.	Insufficient centrifugation of the PCR strips, e.g., resuspended PCR mix is still in the upper part of the vessel or bubbles trapped in the mix.	Always centrifuge PCR strips. Use the centrifuge models and settings recommended in this manual. Avoid the introduction of air bubbles during pipetting.
	Outer surface of the vessel or the seal is dirty (e.g., by direct skin contact).	Always wear gloves when handling the vessels and seal. Do not mark vessels on the outside of the tubes or directly on top of the reaction mix.

INSTRUCTIONS

2.6 Support

If you have questions or experience any problems with our products, please contact us:



www.hygiena.com/technical-support-request

Our aim is to provide you with a solution as quickly and effectively as possible. We would also like you to contact us if you have any suggestions for improving the product or in case you would like to use our product for a different application. We highly value your feedback.

ADDITIONAL INFORMATION

3. ADDITIONAL INFORMATION

3.1 Testing Principle

The **foodproof**[®] kit provides all necessary reagents and a control template for reliable interpretations of results. To ensure maximum reliability of the kit and to prevent misinterpretation of negative results due to inhibition of the amplification, an Internal Control (IC) is included. A hydrolysis probe was designed to bind specifically the IC, allowing detection in the respective channel, whereas the target DNA is detected in another channel. In case of a negative result due to inhibition of the amplification by the sample DNA of interest, the amplification of the IC is suppressed as well, whereas a negative result for the sample DNA of interest and amplification of the IC clearly indicates the absence of parameter in the sample. The real-time PCR kit minimizes contamination risk and contains all reagents (except for template DNA) needed for the detection of target DNA. Primers and probes provide specific detection of target DNA in food and environmental samples, including primary production stage samples. The described performance of the kit is guaranteed for use only on the real-time PCR instruments listed above.

Step-by-Step Procedure

1. Using the kit's sequence-specific primers in a polymerase chain reaction (PCR), the PCR instrument and the supplied reagents amplify fragments of specific sequences for target DNA.
2. The PCR instrument detects these amplified fragments in real time through fluorescence generated by cleavage of the hybridized probe due to the 5'-nuclease activity of the Taq DNA polymerase. The probe is labeled at the 5'-end with a reporter fluorophore and at the 3'-end with a quencher.
3. During the annealing/elongation phase of each PCR cycle, the probe hybridizes to an internal sequence of the amplicon and is cleaved by the 5' nuclease activity of the Taq DNA polymerase. This cleavage of the probe separates the reporter dye from the quencher dye, increasing the reporter dye signal.
4. The PCR instrument measures the emitted fluorescence of the reporter dye.

Prevention of Carry-Over Contamination

The heat-labile Uracil-DNA N-Glycosylase (UNG) is suitable for preventing carry-over contamination between PCR's. This technique relies on the incorporation of deoxyuridine triphosphate (dUTP) during all amplification reactions, and the pretreatment of all successive PCR mixtures with the heat-labile UNG. The UNG cleaves DNA at any site where a deoxyuridine residue has been incorporated. The resulting abasic sites are hydrolyzed due to the high temperatures during the initial denaturation step, and can no longer serve as PCR templates. The heat-labile UNG is inactivated during the initial denaturation step. Native DNA (e.g., the isolated target genomic DNA) does not contain uracil and is therefore not degraded by this procedure. Since dTTP is replaced with dUTP and UNG is included in this kit, decontamination can be achieved with the provided reagents.

3.2 Trademarks

foodproof[®], **microproof**[®], **vetproof**[®], ShortPrep[®], RoboPrep[®], and LyoKit[®] are trademarks of BIOTECON Diagnostics GmbH.

Hygiena[™] is a registered trademark of Hygiena.

Other brand or product names are trademarks of their respective holders.

3.3 Reference Number

The reference number and original BIOTECON Diagnostics article number: R 302 23.

3.4 Change Index

Version 5, February 2022:

Rebranding, new document layout and updated content.

Hygiena LLC

CA 93012 Camarillo
USA

www.hygiena.com/technical-support-request

Manufactured by

**BIOTECON
Diagnostics GmbH**

Hermannswerder 17
14473 Potsdam
Germany

bcd@bc-diagnostics.com
www.bc-diagnostics.com