

foodproof[®]

StarPrep[®] Five Kit

PRODUCT INSTRUCTIONS

Documentation for the rapid extraction of animal DNA
for direct use in PCR

Product No. KIT230191

foodproof®

StarPrep Five Kit

Store kit at 15 °C to 25 °C
FOR *IN VITRO* USE ONLY

Product No. KIT230191
Kit for 96 reactions

Product Instructions
Revision A, January 2024

TABLE OF CONTENTS

1. OVERVIEW 4

1.1. General Information 4

1.2. Applicability..... 4

1.3. Kit Contents 5

2. INSTRUCTIONS 6

2.1. Required Material 6

2.2. Precautions and Preparations..... 7

2.3. Workflows 8

 2.3.1. Extraction Procedure 9

2.4. Troubleshooting 11

2.5. Support..... 12

3. ADDITIONAL INFORMATION 13

3.1. General Information 13

3.2. Trademarks 14

3.3. Reference Number 14

3.4. Change Index..... 14

1. OVERVIEW

The foodproof® StarPrep® Five Kit is designed for the rapid preparation of animal DNA for direct use in PCR. The entire DNA preparation can be performed in a single tube, minimizing handling steps and exposure to biohazardous material. The reduced number of handling steps results in time saving and, because transfer steps of DNA containing extracts are not necessary, the cross-contamination risk is minimized.

1.1. General Information

Number of Reactions

The kit is designed for 96 reactions.

Storage Conditions

Store at 15 to 25 °C.

The components of the foodproof StarPrep Five Kit are guaranteed to be stable through the expiration date printed on the label.

1.2. Applicability

The foodproof StarPrep Five Kit can be used to prepare DNA from up to 200 mg food, feed or pharmaceutical products (e.g. gelatin capsules) with only a few handling steps in one single tube. The quality of the DNA obtained with the kit is suitable for any PCR application. The method has been optimized for the foodproof LyoKits.

1.3. Kit Contents

A schematic representation of the foodproof StarPrep Five Kit with all its components.

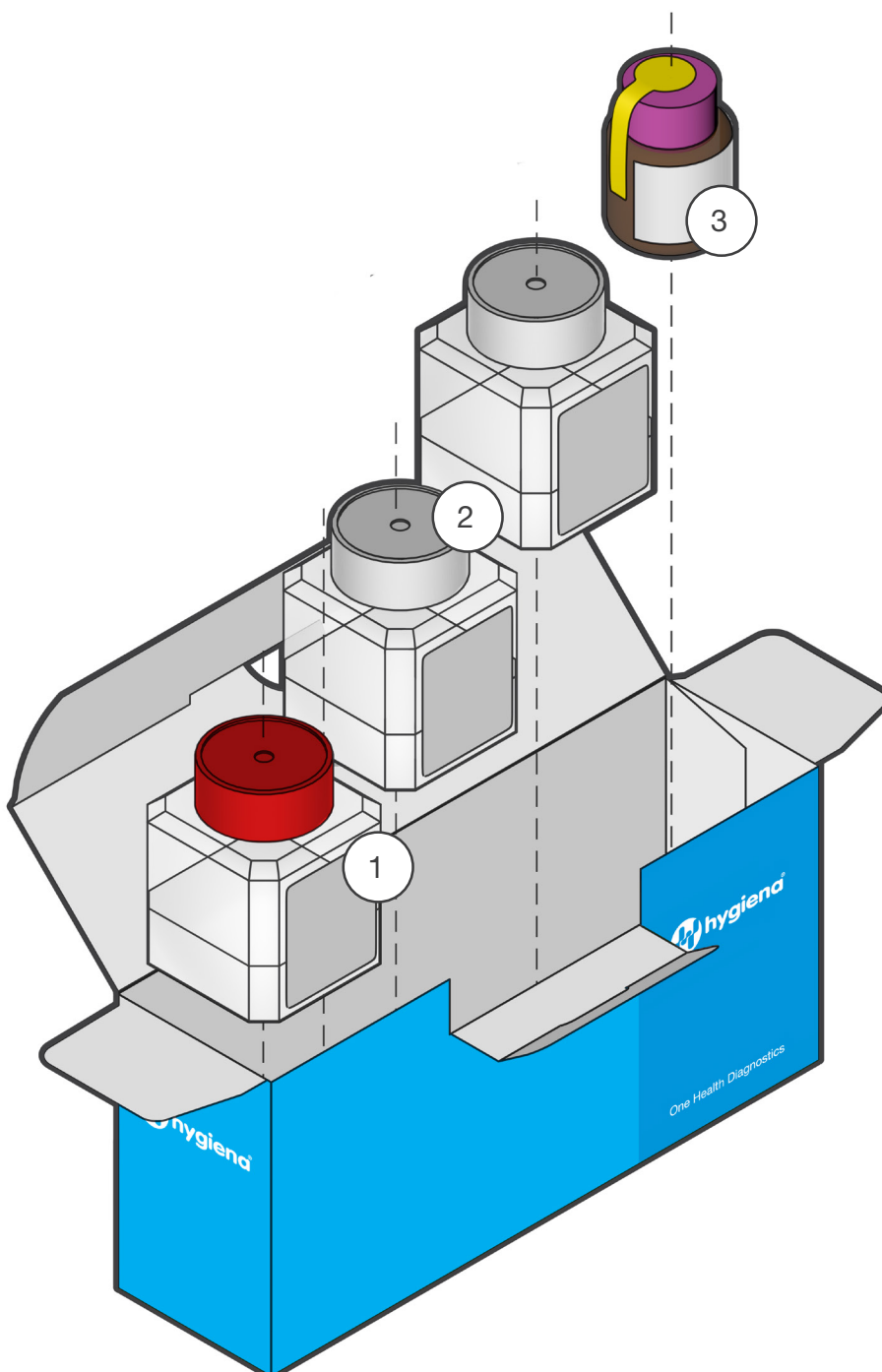

1. Lysis Buffer (30 mL)
2. 2x Buffer M (2x 25 mL)
3. Proteinase K (100 mg)

2. INSTRUCTIONS

This section provides all information for a seamless DNA extraction from a variety of matrices.

2.1. Required Material

Most of the required equipment and reagents are available through Hygiena® Diagnostics. Please contact us for further information.



It is highly recommended only to use the materials described below to guarantee the robustness of the method.

Equipment

- Standard tabletop **microcentrifuge** capable of a 8,000 × g centrifugal force
e.g. *Micro Star 17 - VWR*

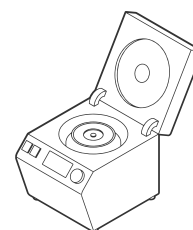

- 2x heating unit** suitable for 2 mL tubes
e.g. *AccuBlock™ - Labnet with heating block*

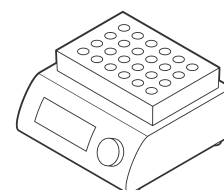

- Vortex mixer or multi plate shaker**
e.g. *Vortex Genie - Scientific Industries or
MPS-1 High-Speed Multi Plate Shaker - Biosan*

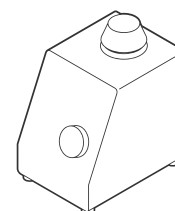

Optional

- Multichannel pipette** and filter tips
e.g. *VOYAGER electronic 8-channel pipette with adjustable tip spacing, 10 - 300 µL*
and *VOYAGER electronic 8-channel pipette with adjustable tip spacing, 50 - 1,250 µL*



Consumables

- Sterile **reservoir**

25 mL

100 mL

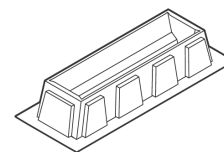

Reagents

- Double distilled water

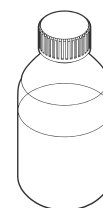

2.2. Precautions and Preparations

Follow all universal safety precautions governing work with biohazardous materials, e.g., wear lab coats and gloves at all times. Properly dispose of all contaminated materials, decontaminate work surfaces, and use a biosafety cabinet whenever aerosols might be generated.

For more information, please refer to the appropriate safety data sheet (MSDS). The MSDS is available online at www.hygiena.com/sds.

- Always use filter tips in order to avoid cross-contamination.

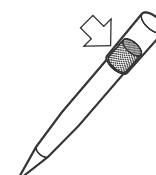

- Warm one heating unit to 72 °C, the other heating unit to 95 to 100 °C.

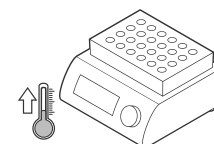

- Prepare **Proteinase K** before using it the first time: dissolve Proteinase K in 5 mL double-distilled water, aliquot solution. Store aliquots at -15 to -25 °C, stable for 12 months.



2.3. Workflows

The following procedure describes the rapid extraction of animal DNA from 200 mg sample material like minced meat, processed foods, feed, pharmaceutical capsules, gelatin and milk. When using the electronic 8-channel pipettes with adjustable tip spacing, 8 samples can be pipetted and processed at a time.

2.3.1. EXTRACTION PROCEDURE

This protocol describes the DNA isolation from 200 mg food, feed or pharmaceutical products.

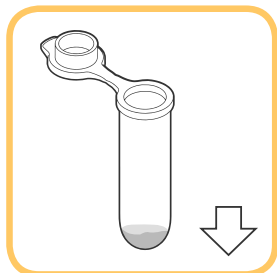

1. ADD SAMPLE

Weigh out **200 mg sample** and transfer the sample in a 2 mL reaction tube.

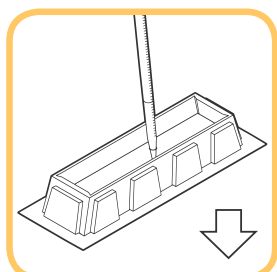

2. PREPARE PREMIX (N+1 REACTIONS)

Transfer $(n+1) \times 300 \mu\text{L}$ of **StarPrep Five Lysis Buffer**, $(n+1) \times 500 \mu\text{L}$ of **Buffer M** and $(n+1) \times 45 \mu\text{L}$ of **Proteinase K** to a sterile reservoir.

Where n = number of samples, plus one additional volume to adjust for pipetting errors. (For example, mix 1,800 μL of StarPrep Five Lysis Buffer with 3,000 μL of Buffer M and 270 μL Proteinase K for five (n) DNA preparations)

Note: Shake lysis buffer before use.

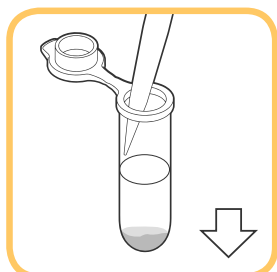

3. ADD PREMIX TO SAMPLE

Transfer **845 μL of premix** (step 2) to the 2 mL sample reaction tube (step 1).

Note: Take care that buffer is mixed in the reservoir by pipetting up and down just before pipetting to the sample.

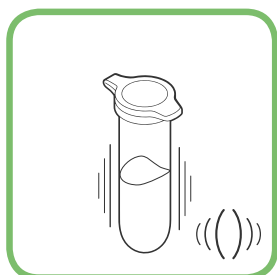

4. MIX

Vortex for 5 sec or shake on the Biosan MPS-1 High-Speed Multi Plate Shaker at 2,800 rpm for 15 sec.

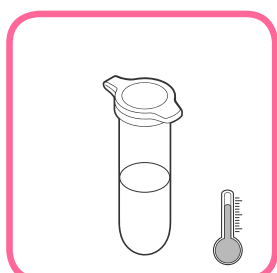

5. INCUBATE AT 72°C

15 min at 72°C in the heating unit.

Note: Gelatin in the samples must be completely dissolved: mix by inverting the tube after 60 sec of incubation at 72 °C, then start incubation for 15 min.

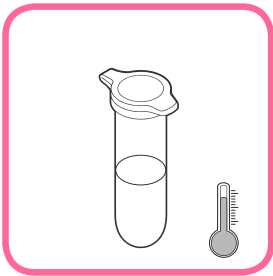

6. INCUBATE AT 95°C

15 min at 95°C in the heating unit.

Carefully remove the reaction tube from the heating unit and allow the tube to sit for **1 min at 15 to 25 °C**.

Note: If only one heating unit is used, make sure that temperature has reached 95 °C.



7. CENTRIFUGE

5 min at 13,000 x g.

SUPERNATANT FOR DETECTION

Use 3 µL extract for the foodproof PCR LyoKits.

Note: Strictly avoid transferring fractions of the sediment to the PCR reaction, because this might cause PCR inhibition.

For later analysis, store DNA at -15 to -25 °C.

After thawing, mix briefly by vortexing and centrifuge at 13,000 × g for 4 min.

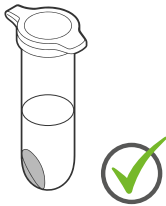

2.4. Troubleshooting

| Problem | Possible Cause | Recommendation |
|-------------------------|---|--|
| Extract inhibits PCR | DNA extract contains too many PCR inhibitors. | Dilute DNA extract, e.g., 1:10, or reduce the amount of extracted DNA, e.g. for LyoKits 5 µL instead of 25 µL. |
| Low DNA yield or purity | Improper storage of kit components. | Store kit reagents at 15 to 25°C. Close all reagent bottles tightly after each use to preserve pH and stability, and to prevent contamination. |
| | | After any lyophilized reagent is reconstituted, aliquot it, then store the aliquots at -15 to -25 °C. |
| | Precipitates have formed. | If precipitates have formed, warm the solutions at 15 to 25 °C or in a 37 °C water bath until the precipitates have dissolved. |
| | Reagents and samples not completely mixed. | Always mix the sample tube well after addition of each reagent. |
| | Homogenization of food sample not sufficient. | Use a mortar and pestle or a commercial product, such like mixer or bead mills for disruption/ homogenization. |
| | Suboptimal reaction conditions. | Ensure proper disruption and heating conditions. Verify correct temperature of the heating block with a thermometer. |

2.5 Support

If you have questions or experience any problems with our products, please contact us:



www.hygiena.com/support

Our aim is to provide you with a solution as quickly and effectively as possible. We would also like you to contact us if you have any suggestions for improving the product or in case you would like to use our product for a different application. We highly value your feedback.

3. ADDITIONAL INFORMATION

3.1 General Information

Quality Control

All products are regularly monitored by our quality control. You can find the certificate of analysis (COA) on our website. If you would like to carry out your own quality control, you will find the analysis method described in the certificate.

Waste Disposal

All contaminated and potentially infectious material, like enrichment cultures or food samples, should be autoclaved before disposal and eliminated according to local rules and regulations. For proper disposal of unused chemicals, please refer to the SDS.

Warranty and Disclaimer of Liability

“Limited Warranty” and “Disclaimer of Liability”: Hygiena Diagnostics GmbH warrants that this product is free from defects in materials and workmanship through the expiration date printed on the label and only if the following are complied with:

- (1) The product is used according to the guidelines and instructions set forth in the product literature;
- (2) Hygiena Diagnostics GmbH does not warrant its product against any and all defects when: the defect is as a result of material or workmanship not provided by Hygiena Diagnostics GmbH; defects caused by misuse or use contrary to the instructions supplied, or improper storage or handling of the product;
- (3) All warranties of merchantability and fitness for a particular purpose, written, oral, expressed or implied, shall extend only for a period of one year from the date of manufacture. There are no other warranties that extend beyond those described on the face of this warranty;
- (4) Hygiena Diagnostics GmbH does not undertake responsibility to any purchaser of its product for any undertaking, representation or warranty made by any dealers or distributors selling its products beyond those herein expressly expressed unless expressed in writing by an officer of Hygiena Diagnostics GmbH;
- (5) Hygiena Diagnostics GmbH does not assume responsibility for incidental or consequential damages, including, but not limited to responsibility for loss of use of this product, removal or replacement labor, loss of time, inconvenience, expense for telephone calls, shipping expenses, loss or damage to property or loss of revenue, personal injuries or wrongful death;
- (6) Hygiena Diagnostics GmbH reserves the right to replace or allow credit for any modules returned under this warranty.

3.2 Trademarks

foodproof®, microproof®, vetproof®, ShortPrep®, StarPrep®, RoboPrep® and LyoKit® are registered trademarks of Hygiena Diagnostics GmbH.

Hygiena® is a registered trademark of Hygiena.

Other brand or product names are trademarks of their respective holders.

3.3 Reference Number

The reference number and original Hygiena Diagnostics GmbH

article number: S 400 21

3.4 Change Index

Version 1, March 2020:

New document layout and content.

Revision A, December 2023:

Rebranding and new layout

S 400 21 20 -> INS-KIT230191-REVA

Hygiena®

Camarillo, CA 93012
USA

diagnostics.support@hygiena.com

Manufactured by

Hygiena Diagnostics GmbH

Hermannswerder 17
14473 Potsdam
Germany

www.hygiena.com